

1 2 3 4 5 6 7 8

A
B
C
D
E
F
G
H

A
B
C
D
E
F
G
H

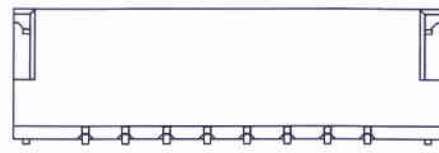
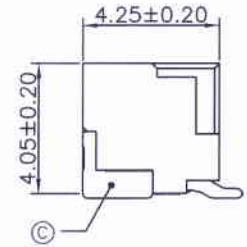
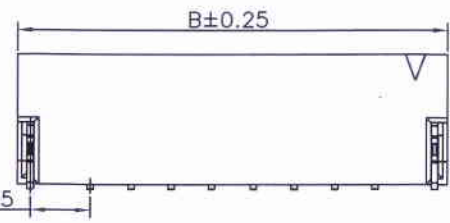
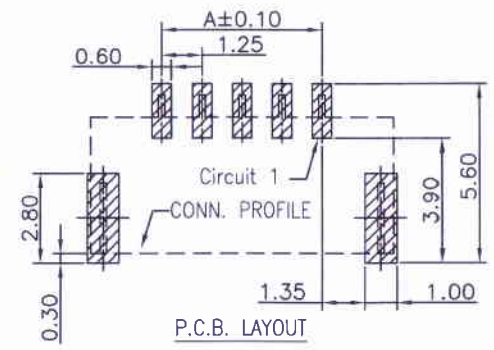
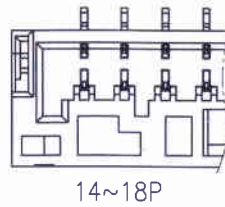
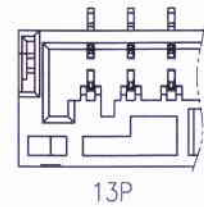
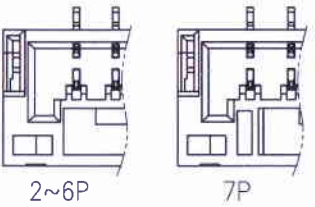
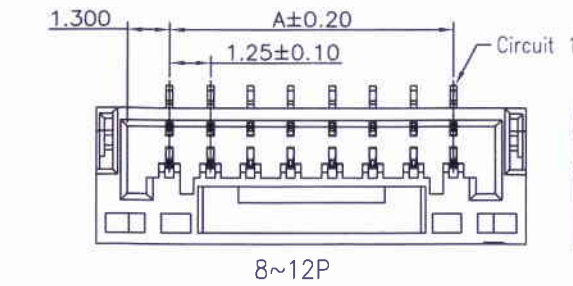

Circuits	Dimensions		
	A	B	C
2P	--	5.75	2.05
3P	2.50	7.00	3.30
4P	3.75	8.25	4.50
5P	5.00	9.50	6.70
6P	6.25	10.75	6.70
7P	7.50	12.00	6.70
8P	8.75	13.25	6.70
9P	10.00	14.50	6.70
10P	11.25	15.75	6.70
11P	12.50	17.00	6.70
12P	13.75	18.25	6.70
13P	15.00	19.50	8.65
14P	16.25	20.75	8.65
15P	17.50	22.00	8.65
16P	18.75	23.25	8.65
17P	20.00	24.50	8.65
18P	21.25	25.75	8.65

Specifications:
 Rated Voltage : 50V AC/DC
 Rated Current : 1A AC,DC
 Withstand Voltage : 500V AC/minute
 Contact Resistance : 30mΩ(MAX.)
 Insulation Resistance : 100MΩ(MIN.)
 Temperature Range : -25°C~+85°C
 The product using material and processing must conform to the *WI-PZ-142* HSF technical standard control requirements

- 11257W00-NP-S-R
 ① ② ③ ④ ⑤
- ① Series No.
 - ② W90 : Side Contact
W00 : Up Contact
 - ③ No. of Circuits
 - ④ S : SMT Type
 - ⑤ R : Tape & Reel

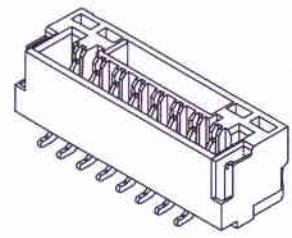
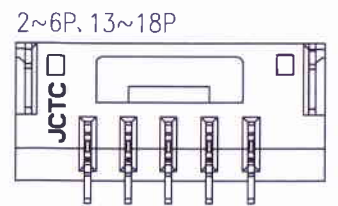
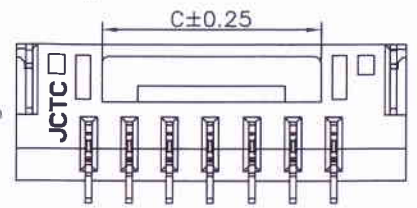
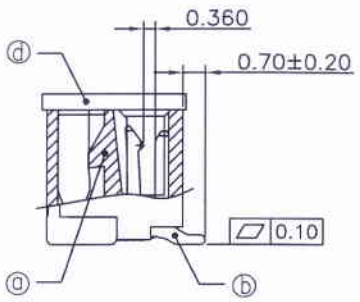
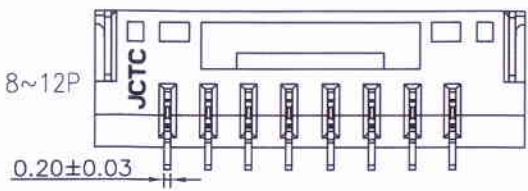

No.	Description	Material	Color
a	Insulator	LCP,UL94V-0	Natural(Beige)
b	Pin Terminal	Phosphor Bronze/Tin-plated	--
c	Solder Tabs	Brass/Tin-plated	--
d	CAP	LCP,UL94V-0	Natural(Beige)

REV.	REVISION RECORD	DATE	GENERAL TOLERANCES	SCALE:	NAME	DATE	PART. NO:	DWG. NO:	 TERMINAL&CONNECTORS
A0	换图框发行	16.11.07	LINER	1:1			11257W00-NP-S-HF-R	ENDE05	
A1	WN2009240266	20.09.28	ANGLES	APPROVED	李占梅	20.09.28	TITLE:		
			0.0±0.25	X° REF±6°	DESIGNER	李占梅	GHR 1.25mm PITCH 180° SMT WAFER		
			0.00±0.15	X° ±3°	DRAWN	李占梅			REV: A1
			0.000±0.08	X° X'±2°					SHEET: 1/2

1 2 3 4 5 6 7 8

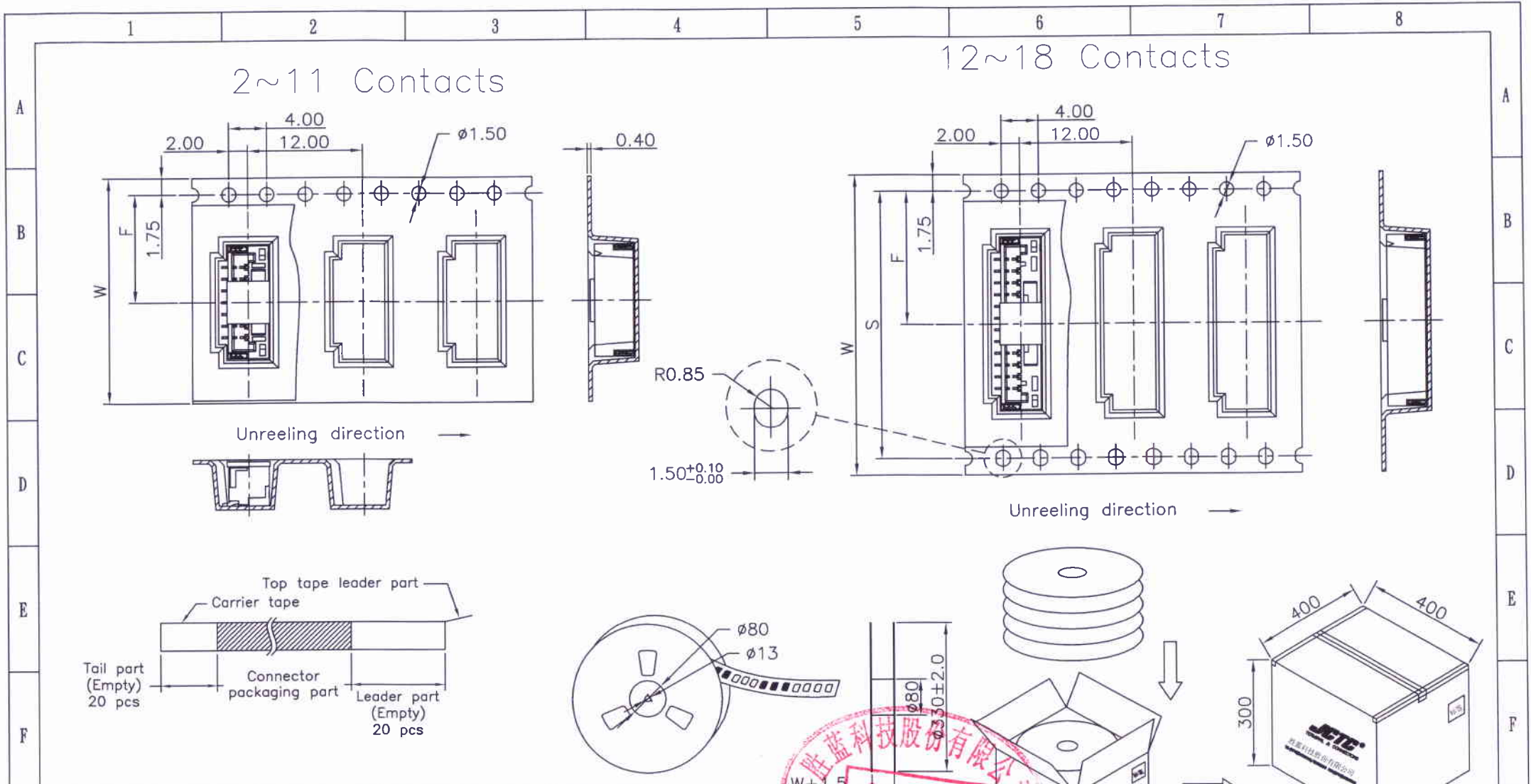

Number of Contacts	W±0.3	F±0.1	S±0.1	pcs/Reel	pcs/Box
2~5P	16	7.50	/	1,000	14,000
6~11P	24	11.50		1,000	10,000
12~16P	32	14.20	28.40	1,000	8,000
17~18P	44	22.20	40.40	1,000	6,000

REV.	REVISION RECORD	DATE	GENERAL TOLERANCES	SCALE:	NAME	DATE	PART. NO:	DWG. NO:
A0	新版图面发行	16.11.07	LINEAR	1:1			11257W00-NP-S-HF-R	ENDE05
A1	WN2009240266	20.09.28	0.0±0.25	APPROVED	李占梅	20.09.28		
			0.00±0.15	DESIGNER	李占梅	20.09.28	TITLE:	
			0.000±0.08	DRAWN	李占梅	20.09.28	GHR 1.25mm PITCH 180° SMT WAFER	



REV: A1 SHEET: 2/2