

RoHS

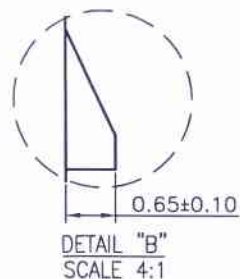

Specifications:
 Voltage Rating : 250V AC/DC
 Current Rating : 3A AC,DC
 Withstand Voltage : 1000V AC/minute
 Contact Resistance : 10mΩ(MAX.)
 Insulation Resistance : 1000MΩ(MIN.)
 Temperature Range : -25°C~+85°C

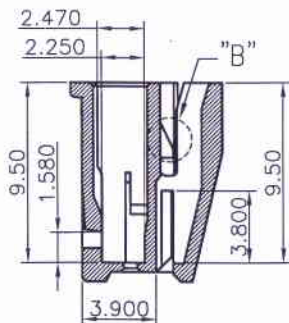
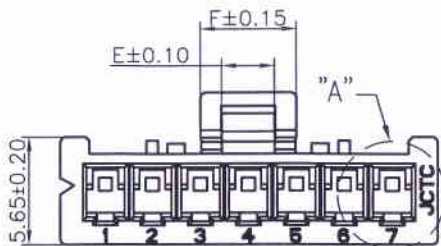
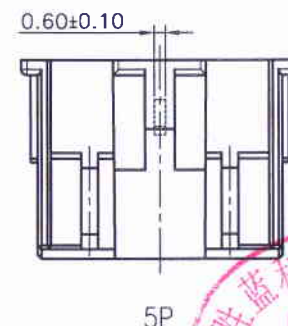
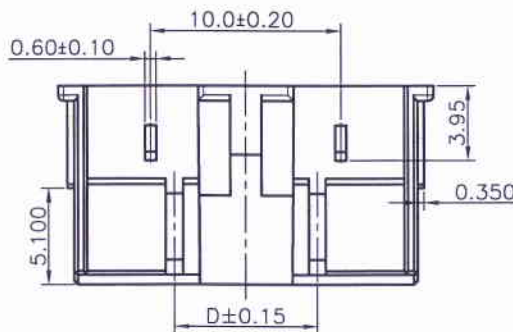
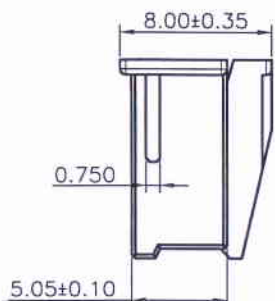
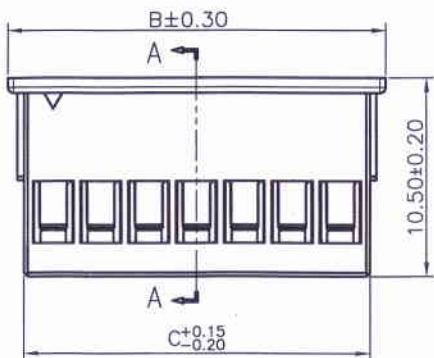
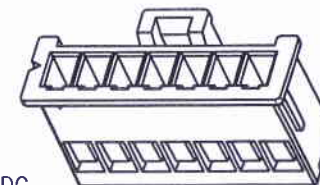

5P

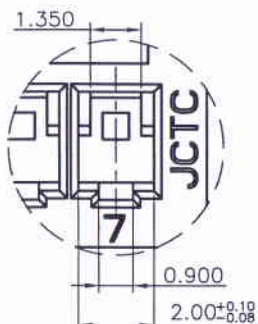
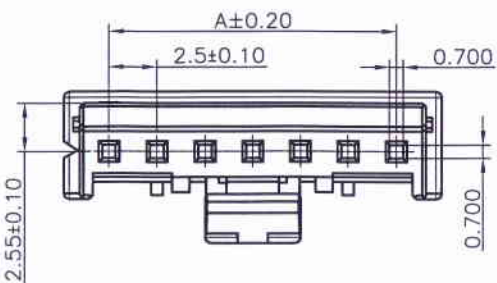

12505H00-NP-L1-HF-NK

- ① Series No.
- ② H90 : Side Contact
H00 : Up Contact
- ③ No. of Circuits
- ④ L1: With Lock
- ⑤ HF: Halogen Free
- ⑥ NK: No Mark



Circuits Part No	Dimensions					
	A	B	C	D	E	F
5P	10.00	14.80	13.10	7.50	2.75	5.00
7P	15.00	19.80	18.10	7.50	2.75	5.00

Part No.	Material	Color
12505H00-NP-L1-HF	Nylon 66,UL94V-0	Natural(White)

REV.	REVISION RECORD	DATE	GENERAL TOLERANCES	SCALE:	NAME	DATE
C0	新图面发行	13. 12. 16	LINEAR	1:1		
C1	更新公司名称	17. 04. 07	ANGLES	APPROVED		
			0.0±0.25	DESIGNER		
			X° REF±6°	DRAWN		
			UNIT: MM			
			0.00±0.15			
			X° ±3°			
			SIZE: A4			
			0.000±0.08			
			X° X'±2°			

JCTC® 胜蓝科技股份有限公司	PART. NO:
TERMINAL&CONNECTORS 东莞市富智达电子科技有限公司	12505H00-NP-L1-HF
TITLE: XA 2.50mm PITCH HOUSING	DWG. NO: ENDE05
	REV: C1 SHEET: 1/1