

RoHS

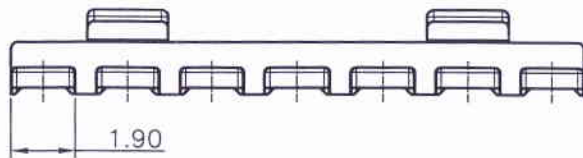
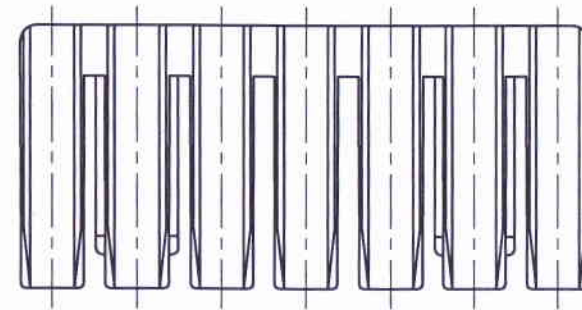
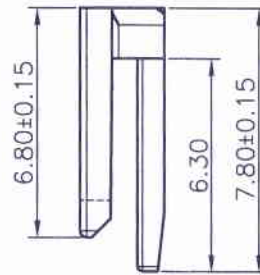
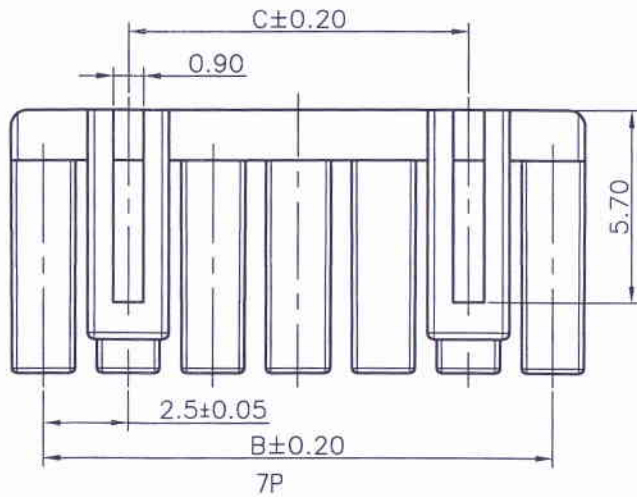
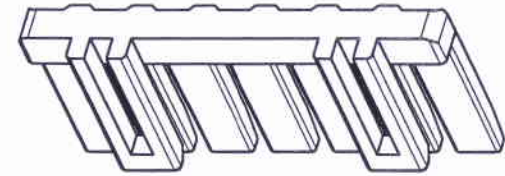
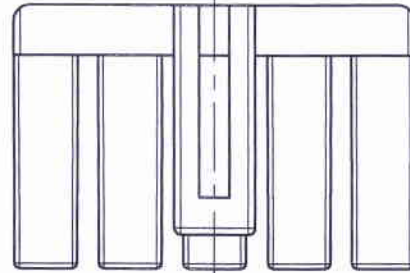
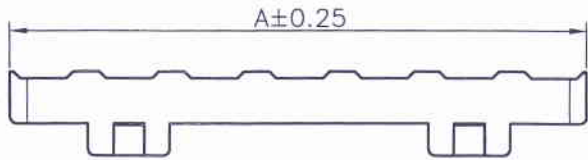

12505K00-NP-L1-HF

① ② ③ ④ ⑤

- ① 系列号
- ② K00 : 零件——铜片
- ③ N : PIN数
- ④ L1 : Lock 1 Type
- ⑤ HF : 锁



Circuits Part No	Dimensions		
	A	B	C
5P	11.95	10.00	--
7P	16.95	15.00	10.00

料号	材质	颜色
12505K00-NP-L1-HF	Nylon 66,UL94V-0	白色

REV.	REVISION RECORD	DATE	GENERAL TOLERANCES		SCALE:	NAME	DATE	<b>JCTC</b> ® 胜蓝科技股份有限公司 TERMINAL&CONNECTORS 东莞市富智达电子科技有限公司 TITLE: XA 2.50mm Pitch Housing 锁片	PART. NO:
C0	新图面发行	13.12.16	LINEAR	ANGLES	1:1				12505K00-NP-L1-HF
C1	更新公司名称	17.04.28	0.0±0.25	X° REF±6°	APPROVED	伍文聪	28/4-17		DWG. NO:
			UNIT: MM	0.00±0.15	X° ±3°	DESIGNER	伍文聪		17.04.28
			SIZE: A4	0.000±0.08	X° X'±2°	DRAWN	伍文聪	17.04.28	REV: C1 SHEET: 1/1