

RoHS

Specifications:
 Voltage Rating : 250V AC/DC
 Current Rating : 3A AC,DC
 Withstand Voltage : 1000V AC/minute
 Contact Resistance : 10mΩ(MAX.)
 Insulation Resistance : 1000MΩ(MIN.)
 Temperature Range : -40°C~+105°C

12505W90-NP X -L-HF
 ① ② ③ ④ ⑤ ⑥

- ① Series No.
- ② W90 : Side Contact
W00 : Up Contact
- ③ No. of Circuits
- ④ X : Product color(A--Y)
Blank: Natural type
- ⑤ L : Lock Type
- ⑥ HF : Halogen Free

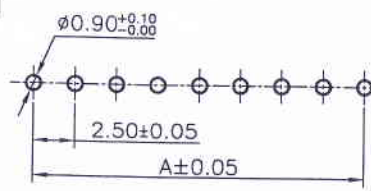
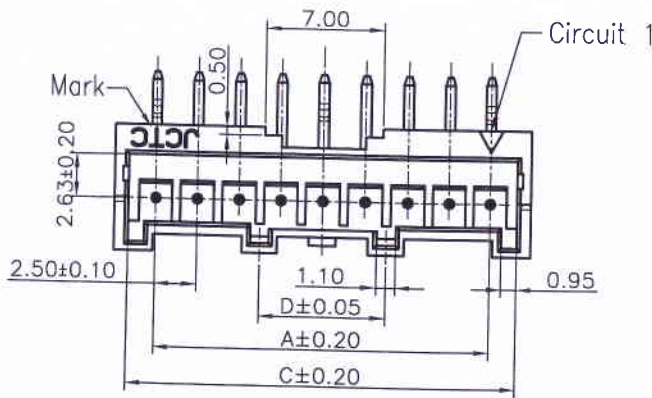
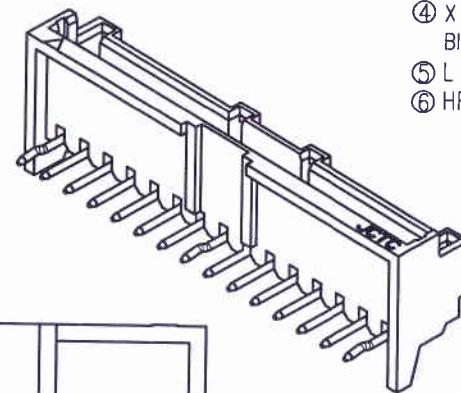

P.C.B. LAYOUT

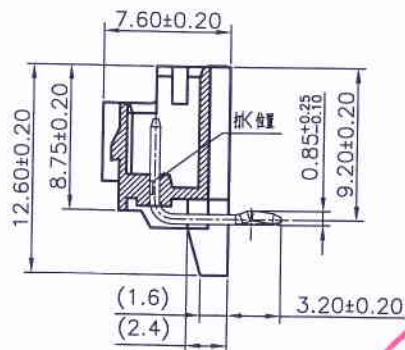
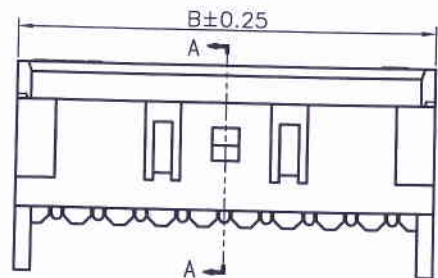

SEC:A-A

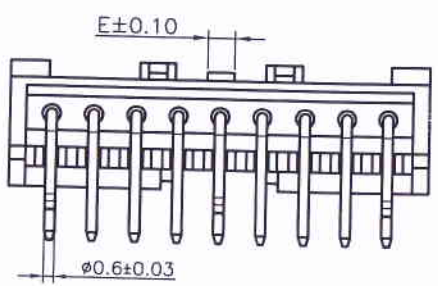
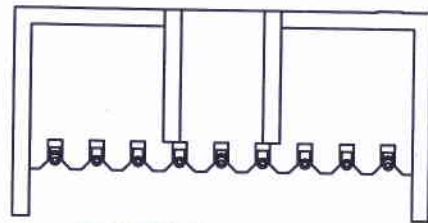

Circuits Part No	Dimensions				
	A	B	C	D	E
5P	10.00	15.00	13.30	7.50	1.60
6P	12.50	17.50	15.80	7.50	1.60
7P	15.00	20.00	18.30	7.50	1.60
8P	17.50	22.50	20.80	7.50	1.60
9P	20.00	25.00	23.30	7.50	1.60
10P	22.50	27.50	25.80	7.50	1.60
11P	25.00	30.00	28.30	7.50	1.60
12P	27.50	32.50	30.80	7.50	1.60
13P	30.00	35.00	33.30	7.50	1.60
14P	32.50	37.50	35.80	7.50	1.60
15P	35.00	40.00	38.30	7.50	1.60



Part No.	Insulator	Contact	Color
12505W90-NP-L-HF	Nylon 66,UL94V-0	Brass/Matte Tin-plated	Natural (White)
12505W90-NPJ-L-HF	Nylon 66,UL94V-0	Brass/Matte Tin-plated	Gray

REV.	REVISION RECORD	DATE	GENERAL TOLERANCES		SCALE: 1:1	NAME	DATE
			LINEAR	ANGLES			
A0	新图面发行	17.03.28	0.0±0.25	X° REF±6°	APPROVED	伍文聪	17.03.28
			0.00±0.15	X° ±3°	DESIGNER	伍文聪	17.03.28
			0.000±0.08	X° X'±2°	DRAWN	伍文聪	17.03.28

JCTC 胜蓝科技股份有限公司
 TERMINAL&CONNECTORS 东莞市富智达电子科技有限公司
 TITLE: 2.50mm PITCH DIP TYPE WAFER

PART NO: 12505W90-NPX-L-HF
DWG NO: ENDE05
REV: A0 SHEET: 1/1