

环保物料

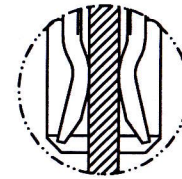

"F" SC=2/1

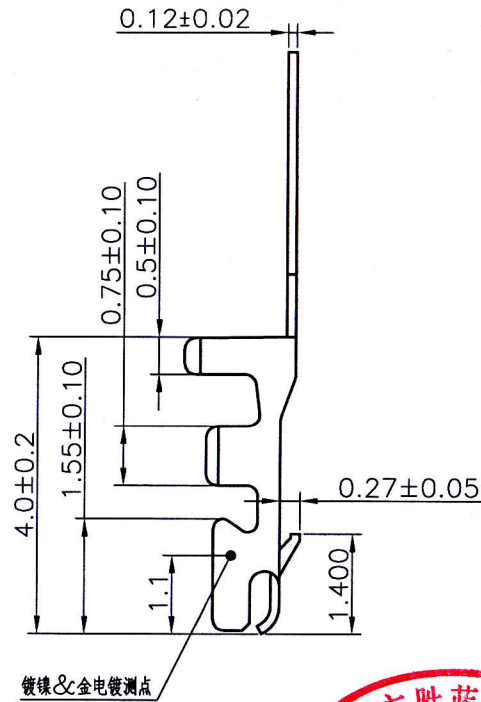
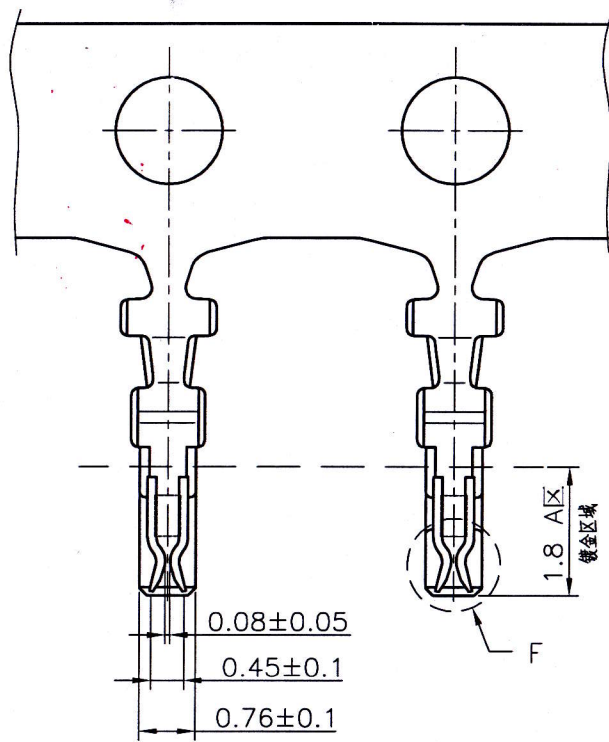
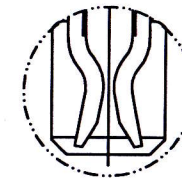

"F" SC=2/1

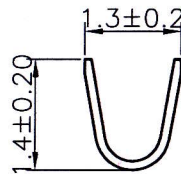

SEC: A-A

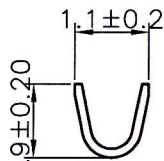

SEC: B-B

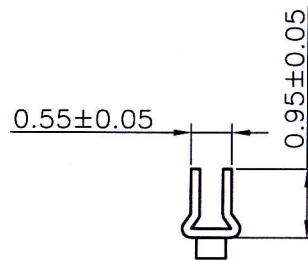

SEC: C-C



11008TOP-0A

P: Phosphor Bronze

0A: Gold-flash

Part No	Wire Range	Insulation O.D.	Material	Finish	Qty/reel
11008TOP-0A	AWG #28~#32	0.60~0.80mm	Phosphor Bronze	Gold-flash	20,000 PCS

REV.	REVISION RECORD	DATE	GENERAL TOLERANCES		SCALE:	NAME	DATE
C0	新图面发行	14.07.02	LINEAR	ANGLES	1:1	邓群庄	7.2.2014
			0.0±0.25	X° REF±6°	APPROVED		
			UNIT: MM	0.00±0.15	DESIGNER		14.7.2
			SIZE: A4	0.000±0.08	DRAWN	邓群庄	14.07.02

<b>JCTC</b> <sup>®</sup> TERMINAL&CONNECTORS 苏州伟聚 东莞胜蓝	PART. NO:	11008TOP-0A
	DWG. NO:	ENDE05
	REV: C0	SHEET: 1/1

TITLE: 1.0mm Crimp Terminal