

环保物料

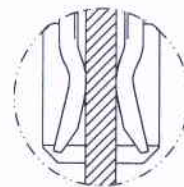

"F" SC=2/1

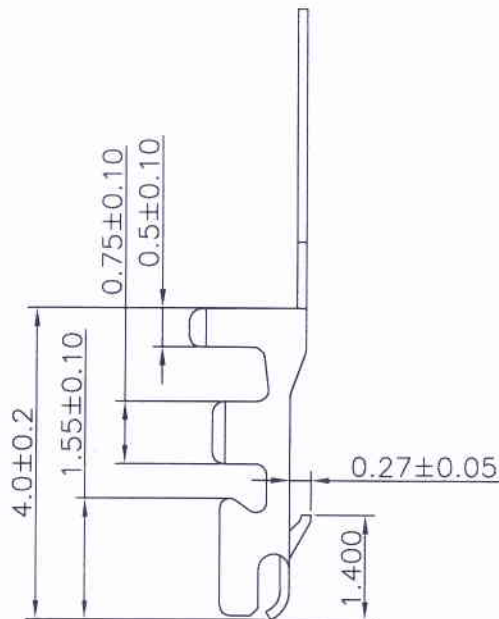
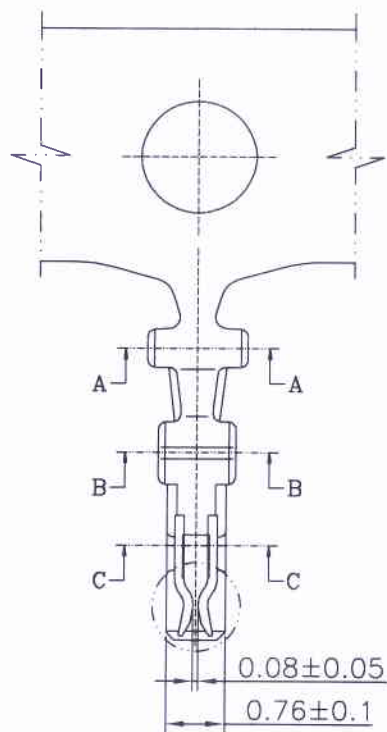
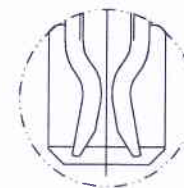

"F" SC=2/1

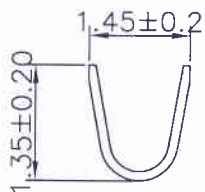

A-A

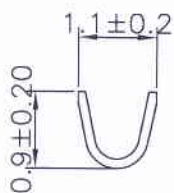

B-B

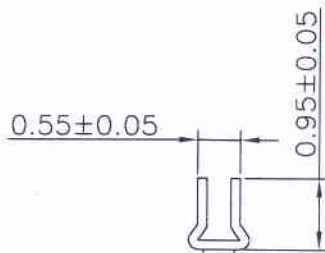

C-C



11008T2P-2E

P: Phosphor Bronze  
2E: Plating After Stamping

Part No	Wire Range	Insulation O.D.	Material	Finish	Qty/reel
11008T2P-2E	AWG #28~#32	0.65~0.92mm	Phosphor Bronze	Tin-plated	20,000 PCS

REV.	REVISION RECORD	DATE	UNIT: MM	GENERAL TOLERANCES		SCALE: 1:1	NAME	DATE	JCTC® TERMINAL & CONNECTORS	□ 苏州伟爽 □ 东莞胜蓝 ■ 东莞胜蓝	PART NO:	
				LINEAR	ANGLES						11008T2P-2E	
A0	新图面发行	16.05.05		0.0±0.25	X° REF ±6°		陈永平	16.05.05			DWG NO:	
				0.00±0.15	X° ±3°		任文彬	16.05.05			ENDE05	
			SIZE: M4	0.000±0.08	X° X' ±2°		王國伟	16.05.05	TITLE: 1.0mm Crimp Terminal		REV: A0	SHEET: 1/1