

Specifications:  
 Rated Voltage : 125V AC/DC  
 Rated Current : 1A AC,DC  
 Withstand Voltage : 250V AC/minute  
 Contact Resistance : 20mΩ(MAX.)  
 Insulation Resistance : 100MΩ(MIN.)  
 Temperature Range : -25°C~+85°C  
 The product using material and processing must conform to the "WI-PZ-142"HSF technical standard control requirements

11255H00-NPX-HF-NK-SX  
 ① ② ③④ ⑤ ⑥ ⑦

- ① Series No.
- ② H90 : Side Contact  
H00 : Up Contact
- ③ No. of Circuits
- ④ X : Product color(A--Y)
- ⑤ HF : Halogen Free
- ⑥ NK : No Mark
- ⑦ S1 : S1 Type  
S2 : S2 Type

Dimensional Ordering Information:				
Circuits Part No	Dimensions			
	A	B	C	D
2P	1.25	2.65	5.72	
3P	2.50	3.90	6.97	
4P	3.75	5.15	8.22	2.50
5P	5.00	6.40	9.47	3.75
6P	6.25	7.65	10.72	5.00
7P	7.50	8.90	11.97	6.25
8P	8.75	10.15	13.22	7.50
9P	10.00	11.40	14.47	8.75
10P	11.25	12.65	15.72	10.00
11P	12.50	13.90	16.97	11.25
12P	13.75	15.15	18.22	12.50
13P	15.00	16.40	19.47	13.75
14P	16.25	17.65	20.72	15.00
15P	17.50	18.90	21.97	16.25
16P	18.75	20.15	23.22	17.50
17P	20.00	21.40	24.47	18.75
18P	21.25	22.65	25.72	20.00
19P	22.50	23.90	26.97	21.25
20P	23.75	25.15	28.22	22.50
26P	31.25	32.65	35.72	22.50
30P	36.25	37.65	40.72	22.50

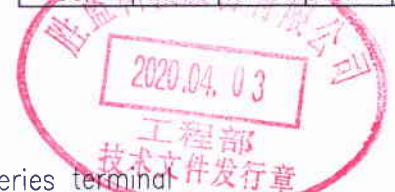
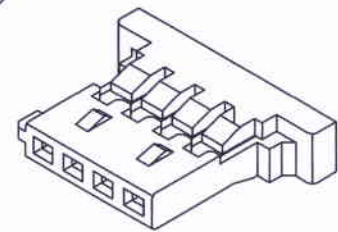
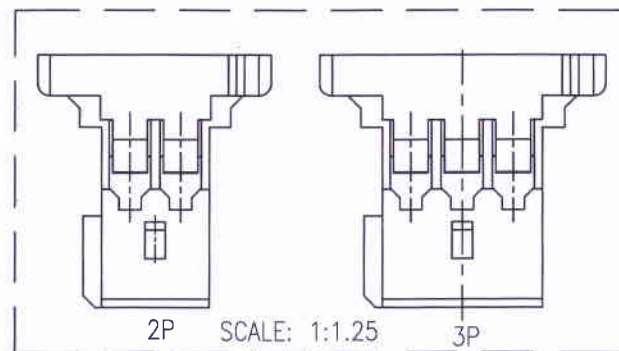
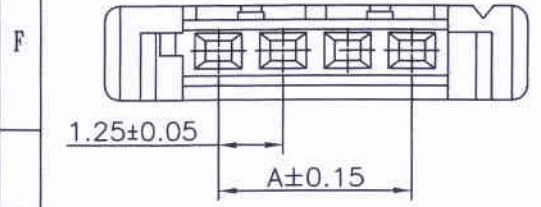
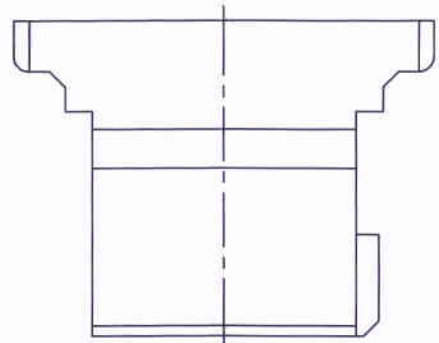
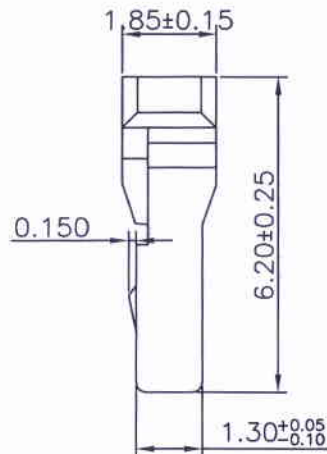
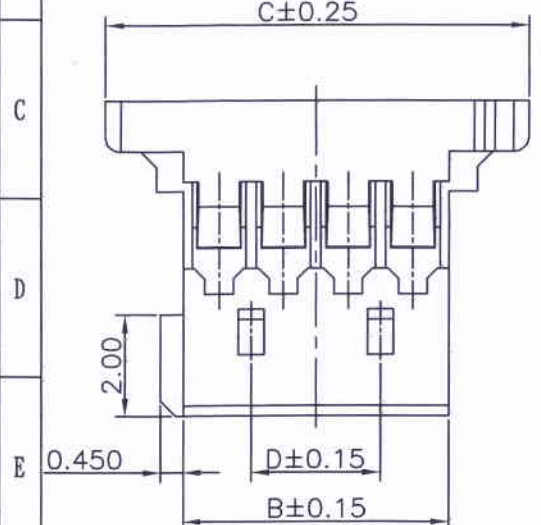
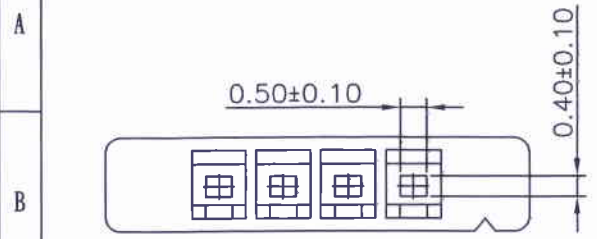

Suitable for JCTC 11255 series terminal

Part No.	Material	Color
11255H00-NPA-HF-NK-S1	Nylon 66,UL 94V-0	黑色无齿
11255H00-NP-HF-NK-S1	Nylon 66,UL 94V-0	本色无齿
11255H00-NP-HF-NK-S2	Nylon 66,UL 94V-0	本色无齿

REV.	REVISION RECORD	DATE	GENERAL TOLERANCES	SCALE:	NAME	DATE	PART NO.:	DWG. NO.:	<b>JCTC</b> <sup>®</sup> TERMINAL&CONNECTORS
C0	新图面发行	14.07.01	LINEAR	1:1			11255H00-NPX-HF-NK-SX	ENDE05	
C1	新增规格	16.01.06	0.0±0.25	APPROVED					
C2	变更公司名称	17.03.14	X° REF±6°	DESIGNER					
C3	HN2004010055	20.04.01	0.00±0.15	X° ±3°	张振坤	20.04.01	TITLE:	51146 1.25mm PITCH HOUSING	
			0.000±0.08	X° X'±2°					REV: C3
									SHEET: 1/1