

环保物料

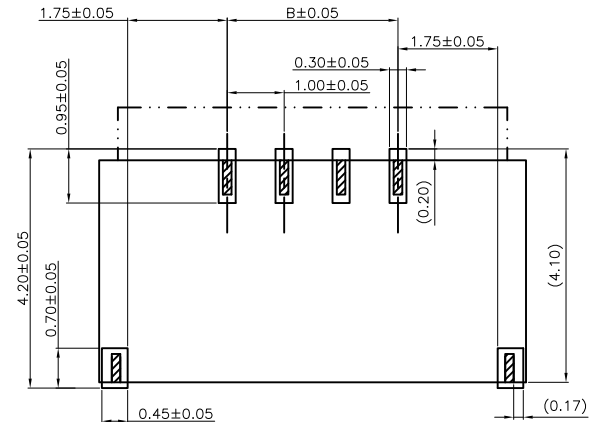
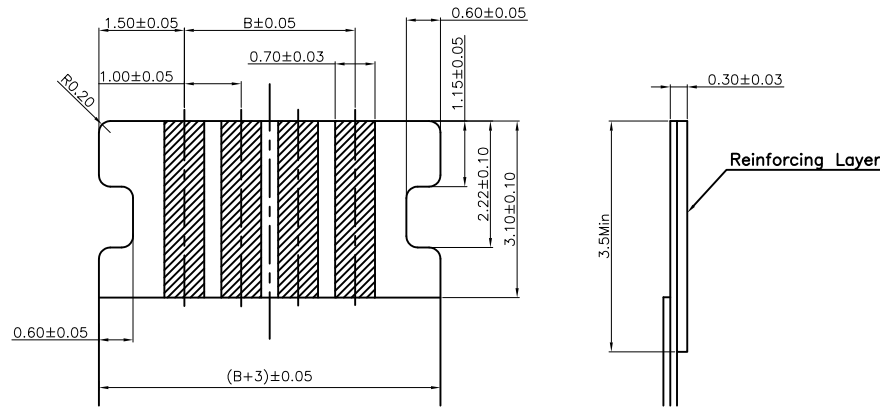
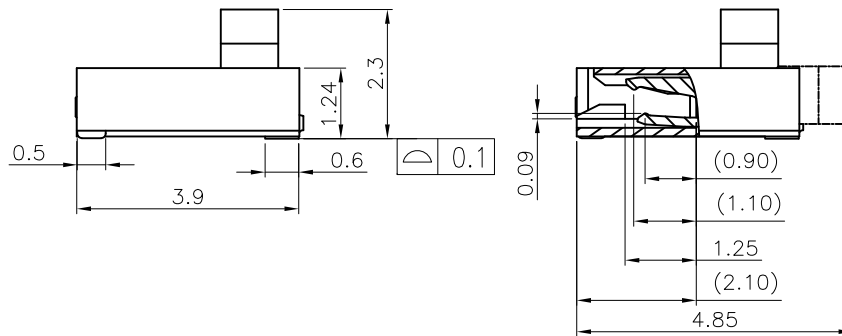
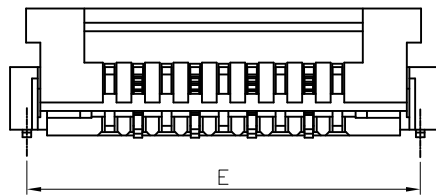
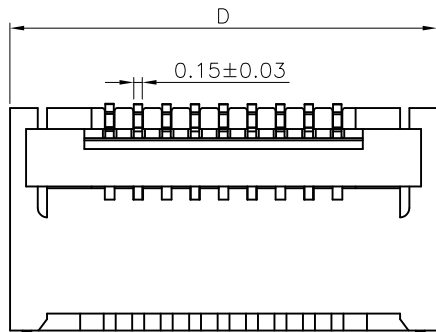
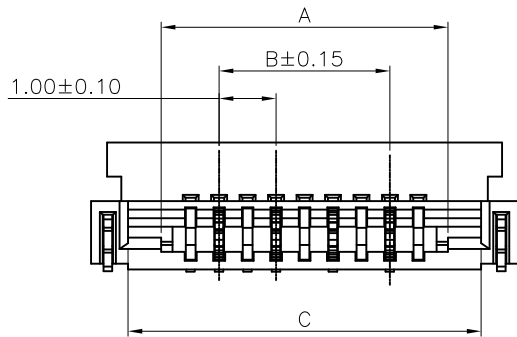

APPLICABLE P.C.B DIMENSION(REF.)

Voltage Rating : 50V AC/DC
 Current Rating : 0.5A AC,DC
 Withstand Voltage : 250V AC/minute
 Contact Resistance : 30mΩ(MAX.)
 Insulation Resistance : 100MΩ(MIN.)
 Temperature Range : -25°C~+85°C

41089W90-NPN-S H L 0A T B R
 ① ② ③④⑤⑥⑦⑧⑨⑩

- ① Series No.
- ② W90 :Right angle
- ③ No. of Circuits
- ④ Color: N=Natural
- ⑤ S: SMT type
- ⑥ H=Halogen Free
- ⑦ Material: L=LCP
- ⑧ Plating for contacts:
0A=1U' Au contact area
- ⑨ Plating for LEG solder area:
T=Matte Tin-plated
- ⑩ Assembly Style
B=Bottom Contacts
- ⑪ R=Tape & Reel

APPLICABLE F.P.C DIMENSION(REF.)

Part No.	Dimensions				
	A	B	C	D	E
4P	5.04	3.00	6.20	7.50	6.91
8P	9.04	7.00	10.20	11.50	10.91

No.	Description	Material	Color/Finish
a	Housing	LCP,UL94V-0	Natural
b	Actuator	LCP,UL94V-0	Black
c	Terminal	C5191R-H	See NOTES
d	LEG	C2680-H	Matte Tin Plating Over Ni

一般公差 GENERAL TOLERANCE

X.X	±0.25	X'	±2'
X.XX	±0.15	X.X'	±1'
X.XXX	±0.08	△	MAJOR DIM.

单位 UNIT
mm

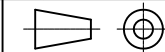

绘图 DR. 程功银
 校对 CHK. 李兴泽
 审核 CHK. 李兴泽
 核准 APPD. 杨章雄

料号 PART NO.
41089W90-NPN-SHLOATBR

文件编号 NUMBER
ENDE05

品名 TITLE
1.0 Pitch 1.2H FPC Connector

JGTC[®]
TERMINAL&CONNECTORS

比例 SCALE 1/1
 SHEET 1/2
 版次 REV. A1

版次 REV.	日期 DATE	变更内容 DESCRIPTION	审核 CHK.	核准 APPD.
A1	20.08.21	更新图框发行	李兴泽	杨章雄
A0	17.07.24	新图面发行	李兴泽	杨章雄

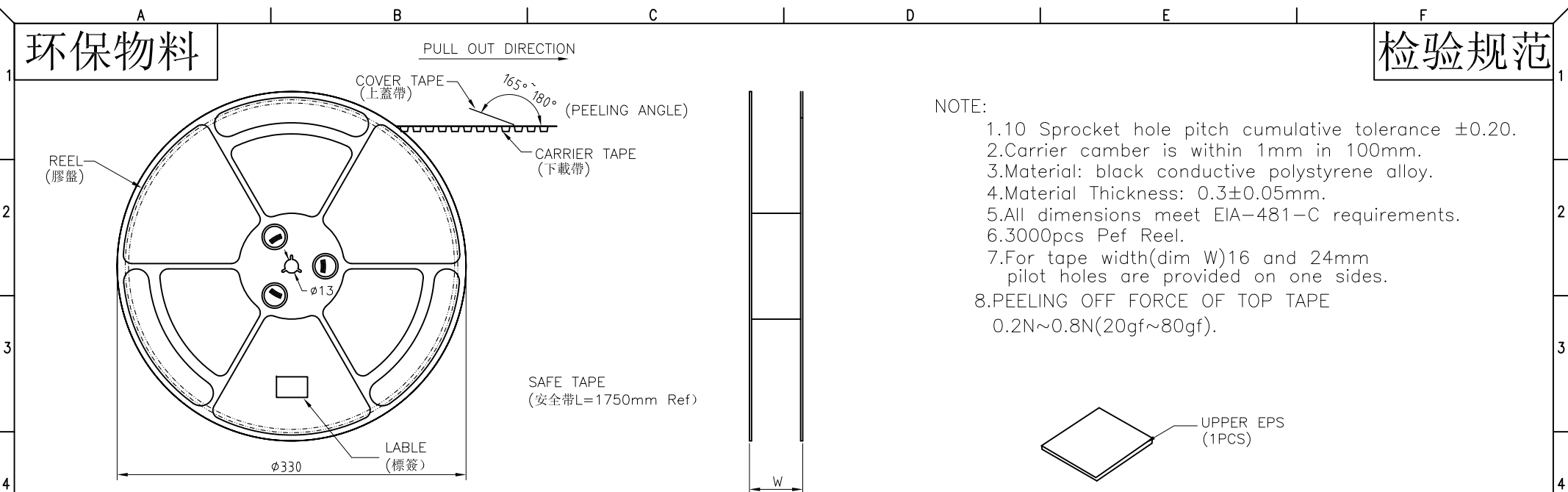

SCALE 1:4

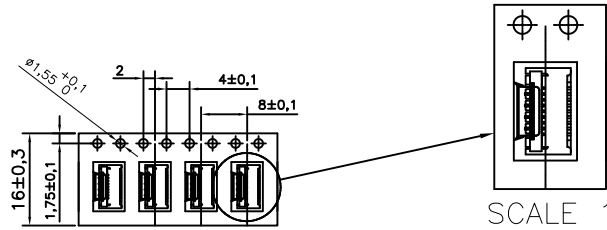

SCALE 1:2

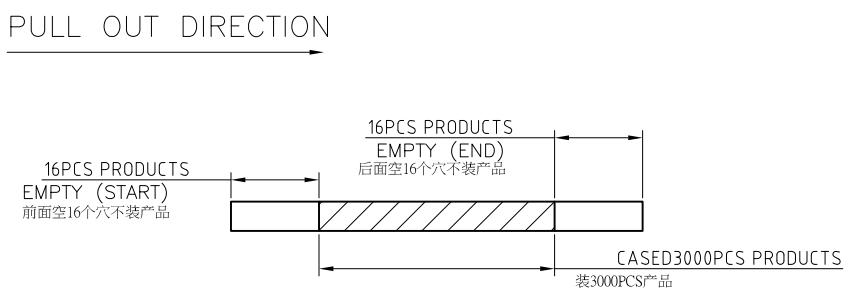

NOTE:

- 1.10 Sprocket hole pitch cumulative tolerance ± 0.20 .
2. Carrier camber is within 1mm in 100mm.
3. Material: black conductive polystyrene alloy.
4. Material Thickness: 0.3 ± 0.05 mm.
5. All dimensions meet EIA-481-C requirements.
6. 3000pcs Pef Reel.
7. For tape width(dim W)16 and 24mm pilot holes are provided on one sides.
8. PEELING OFF FORCE OF TOP TAPE $0.2N \sim 0.8N$ (20gf~80gf).

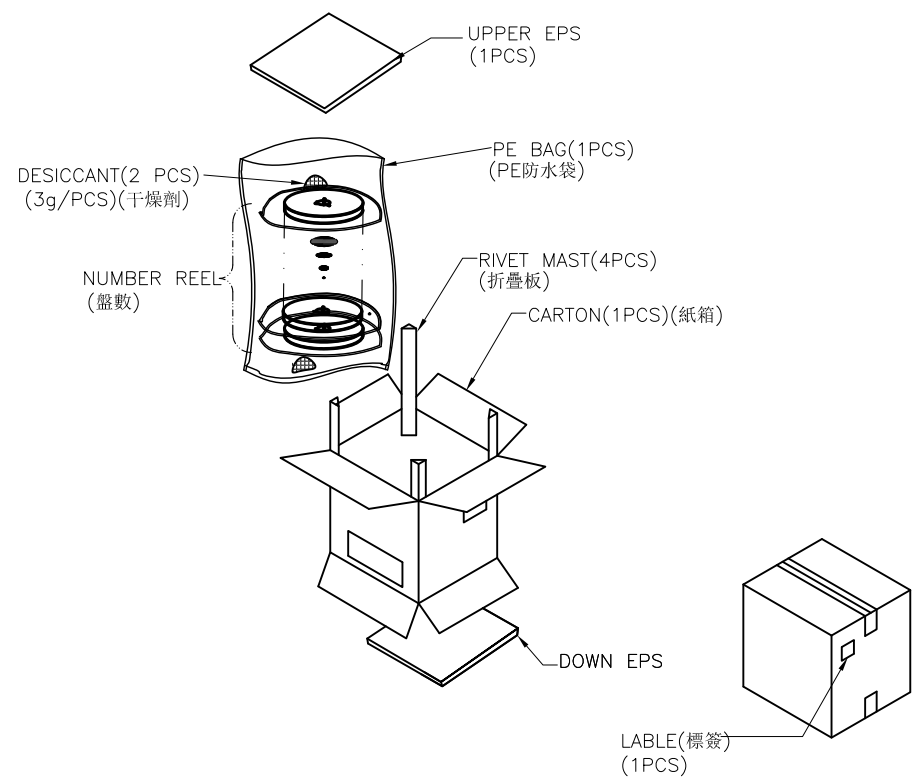

						一般公差 GENERAL TOLERANCE		绘图 DR.	程功银	料号 PART NO.	文件编号 NUMBER	 TERMINAL&CONNECTORS		
						X.X ± 0.15	X* $\pm 2^*$	校对 CHK.	李兴泽	41089W90-4PN-SHLOATBR	ENDPT01			
						X.XX ± 0.05	X.X* $\pm 1^*$	审核 CHK.	李兴泽	品名 TITLE		比例 SCALE	SHEET	版次 REV.
						X.XXX ± 0.02	▲ MAJOR DIM.	核准 APPD.	杨章雄	1.0 Pitch 1.2H FPC Connector		1/1	2/2	A1
版次 REV.	日期 DATE	变更内容 DESCRIPTION	审核 CHK.	核准 APPD.	单位 UNIT	mm								