

1 2 3 4 5 6 7 8

A
B
C
D
E
F
G
H

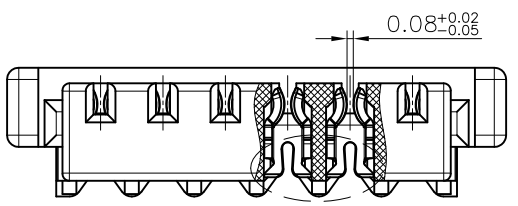

SECTION: A-A

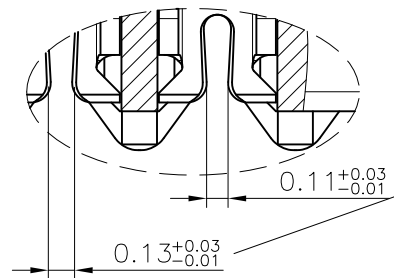

SEC: A-A
SCALE: 2.5:1

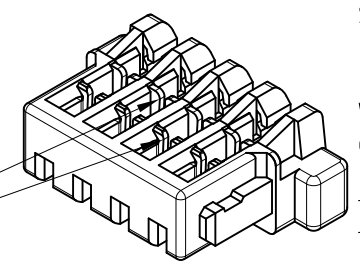

Specifications:
 Rated Voltage : 30V AC/DC
 Rated Current : 0.5A AC,DC
 Withstand Voltage : 200V AC/minute
 Contact Resistance : 30mΩ(MAX.)
 Insulation Resistance : 100MΩ(MIN.)
 Temperature Range : -25°C~+85°C
 The product using material and processing must conform to the "WI-PZ-142"HSF technical standard control requirements

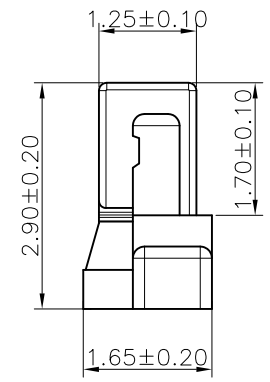
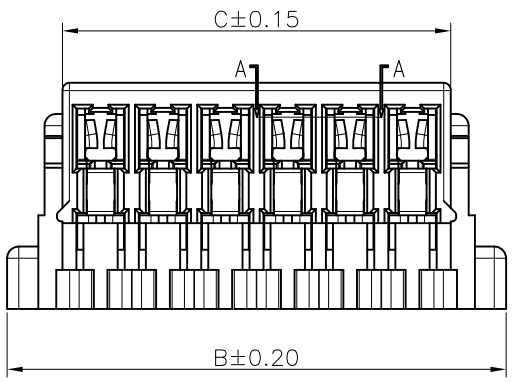

50801H00-NPX-T5A-XX-34-G

- ① Series No.
- ② H90 : Side Contact
H00 : Up Contact
- ③ No. of Circuits
- ④ X : Product color(A--Y)
Blank : Natural type
- ⑤ T : Mount type
- ⑥ 5A : Gold-flash
- ⑦ HF : Halogen Free
- ⑧ 34 : AWG #34
- ⑨ G: Tube

Dimensional Ordering Information:			
Circuits Part No	Dimensions		
	A	B	C
2P	0.80	3.20	1.78
3P	1.60	4.00	2.58
4P	2.40	4.80	3.38
5P	3.20	5.60	4.18
6P	4.00	6.40	4.98
7P	4.80	7.20	5.78
8P	5.60	8.00	6.58
9P	6.40	8.80	7.38
10P	7.20	9.60	8.18
11P	8.00	10.40	8.98

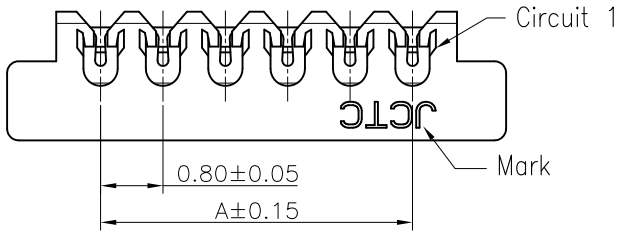

Applicable Wire: AWG #34(Insulation O.D.: 0.32mm)

Part No.	Material	Color	Terminal Material	备注
50801H00-NP-T5A-34-G	Nylon 46,UL94V-0	本色	Phosphor Bronze/Gold-flash	镀全金 1u"
50801H00-NP-T5A-HF-34-G	Nylon 66,UL94V-0	本色无卤	Phosphor Bronze/Gold-flash	镀全金 1u"
50801H00-NPA-T5A-HF-34-G	Nylon 66,UL94V-0	黑色无卤	Phosphor Bronze/Gold-flash	镀全金 1u"

REV.	REVISION RECORD	DATE	UNIT: MM	GENERAL TOLERANCES		SCALE: 1:1	NAME	DATE	PART. NO:	DWG. NO:	 TERMINAL&CONNECTORS
A0	新版发行	20.07.07		SIZE: A4	LINEAR	ANGLES	APPROVED			50801H00-NPX-T5A-XX-34-G	
			0.0±0.25		X° REF±6°	DESIGNER			TITLE:		
			0.00±0.15	X° ±3°	DRAWN	张振坤	20.07.07	JST0.8 刺破0.80mm PITCH HOUSING		REV: A0	
			0.000±0.08	X° X'±2°						SHEET: 1/1	

1 2 3 4 5 6 7 8