

The product using material and processing must conform to the "WL-PZ-001"HSF technical standard requirements

RoHS+HF

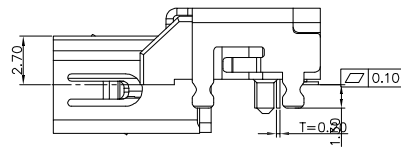
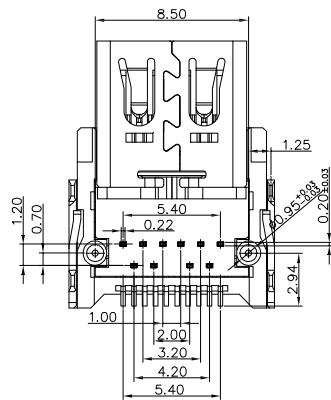
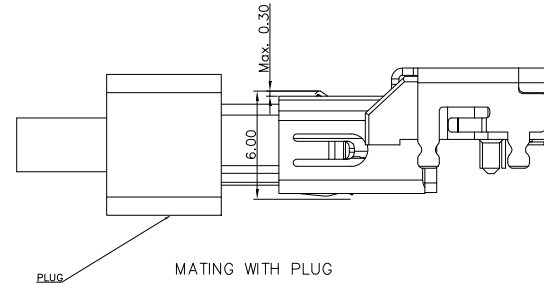
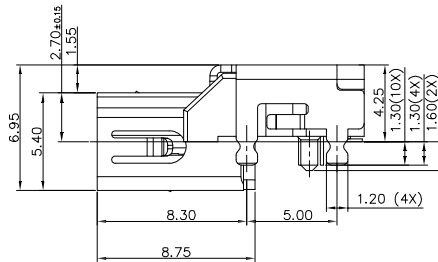
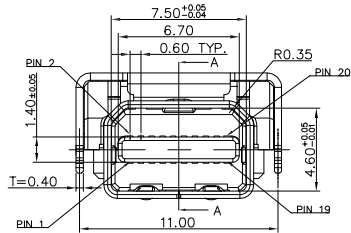
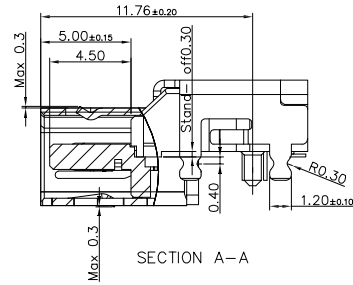
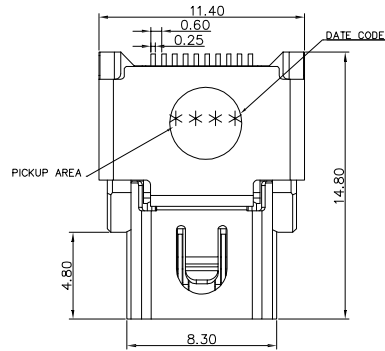

NOTES:

1. MATERIAL:
 - 1.1 HOUSING: HIGH TEMPERATURE THERMOPLASTIC, UL94V-0, COLOR BLACK
 - 1.2 SPACER: HIGH TEMPERATURE THERMOPLASTIC, UL94V-0, COLOR BLACK
 - 1.3 TERMINAL: COPPER ALLOY
 - 1.4 SHELL: METAL.
2. PLATING:
 - 2.1 TERMINAL:
 - UNDERPLATED: NICKEL UNDER PLATING OVER ALL.
 - GOLD FLASH ON CONTACT AREA, MATTE TIN 100u" ON SOLDER AREA.
 - 2.2 SHELL:
 - 50u" MIN. BLACK NICKEL PLATING OVER ALL.
3. DATE CODE: X X XX
 - DAY
 - MONTH
 - YEAR

3.P/N: WL DP F 9-20 8 1 A 0 011

CONNECTOR: DP-DISPLAYPORT

MALE FEMALE: F-FEMALE

ANGLE: 9-90°

COLOR: A-BLACK

PLATING: 1-G/F, 2-AU 3U", 9-Ni

PIN Q' PY: 20PIN

ITEM	DESCRIPTION	REMARK	Q'TY
④	SHELL	METAL,50u" MIN. BLACK NICKEL PLATING OVER ALL	1
③	TERMINAL	COPPER ALLOY,1~3u" Au PLATING ON CONTACT AREA	20
②	SPACER	HIGH TEMPERATURE THERMOPLASTIC, UL94V-0, COLOR BLACK	1
①	HOUSING	HIGH TEMPERATURE THERMOPLASTIC, UL94V-0, COLOR BLACK	1

REV.	REVISION RECORD	DATE	GENERAL TOLERANCES		SCALE:	NAME	DATE	PART.NO:	DWG.NO:	 WanLian Teconology Co., Ltd
AO	NEW RELEASE	22.05.09	LINEAR	ANGLES	1:1	Wang_jr	22.05.09	WLDPF9-2081A0011	ENDE05	
			0.0±0.35	X'REF±6°		DESIGNER	Han_Gao	22.05.09		REV: A0 SHEET: 1/2
			UNIT:mm	X'±3°		DRAWN	LanXuan_Hou	22.05.09	TITLE: CONNECTOR, MINI DP RECEPTACLE REVERSE, C/H=0.00mm	
			SIZE: A4	0.000±0.10						

