

The product using material and processing must conform to the "WL-PZ-001"HSF technical standard control requirements

RoHS

| | | | |
|------|-------------|---|------|
| ③ | SHELL | METAL ALLOY , Ni PLATING | 1 |
| ② | CONTACT | COPPER ALLOY , GOLD PLATING ON CONTACT AREA | 1 |
| ① | HOUSING | HIGH TEMP THERMOPLASTIC ,UL94V-0, BLACK | 1 |
| ITEM | DESCRIPTION | REMARK | Q'TY |

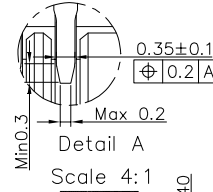
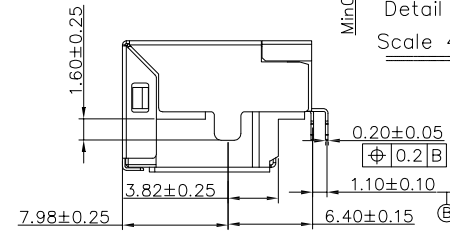
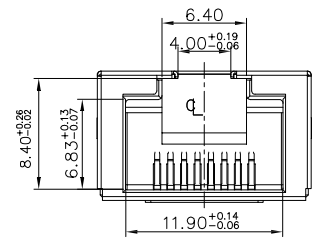
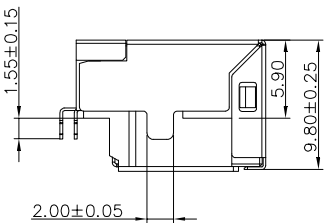
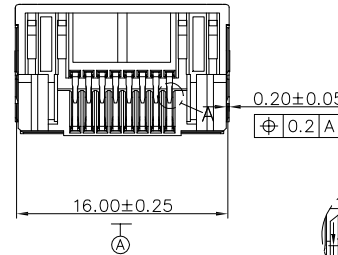
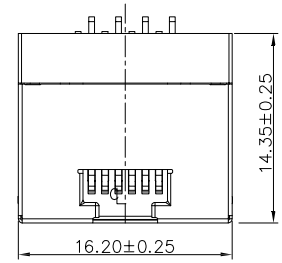
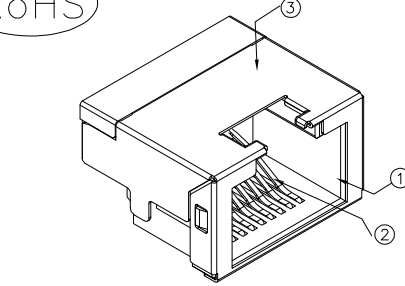

NOTES:
 1.MATERIAL: SEE SHEET
 2. FINISH:
 2.1 TERMINAL: NICKEL UNDERPLATING OVER ALL.GOLD FLASH ON CONTACT AREA, MATTE TIN 100u" ON SOLDER AREA.
 2.2 SHELL:UNDERPLATED: NICKEL PLATING OVER ALL.

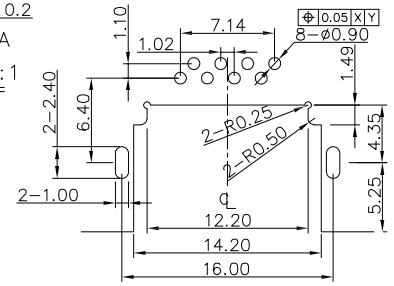

RECOMMENDED P.C.BOARD LAYOUT
 (TOP SIDE) TOLERANCE=±0.05mm PCB T=1.2mm

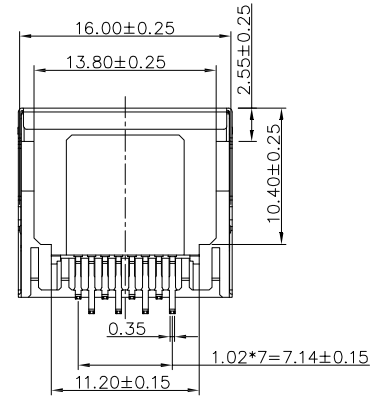
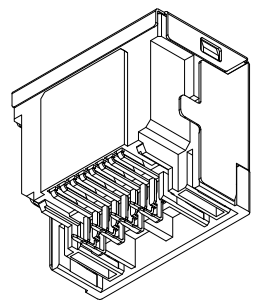

P/N: WL R4 F 9-08 1 1 A 0 102
 CONNECTOR: R4-RJ45
 MALE FEMALE: F-FEMALE
 ANGLE: 9-90°
 PIN Q'PY: 08PIN
 COLOR: A-BLACK
 PLATING: 1-C/F, 3-5U", 5-15U", 6-30U"
 TERMPIPOINT: 1-DIP

| | | | | | | | | | | | |
|------|-----------------|----------|----------|--------------------|----------|------------|-------------|----------|---|---------|--------------------|
| REV. | REVISION RECORD | DATE | | GENERAL TOLERANCES | | SCALE: 1:1 | NAME | DATE | PART.NO: | DWG.NO: | |
| AO | NEW RELEASE | 22.05.09 | | LINEAR | ANGLES | APPROVED | Wang_jr | 22.05.09 | WLR4F9-0811A0102 | ENDE05 | |
| | | | UNIT:mm | 0.00±0.25 | X'±3' | DESIGNER | Han_Gao | 22.05.09 | TITLE: | | REV: A0 SHEET: 1/1 |
| | | | SIZE: A4 | 0.000±0.10 | X'X' ±2' | DRAWN | LanXuan_Hou | 22.05.09 | CONN,RJ45 RECEPTACLE RA DIP W/0,H=5.9mm | | |