

The product using material and processing must conform to the "WL-PZ-001" HSF technical standard control requirements

RoHS

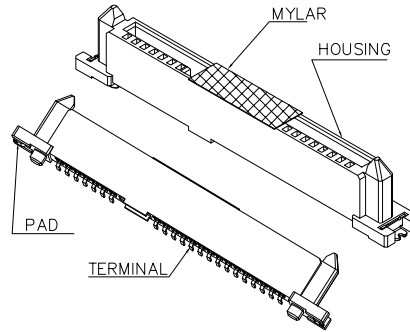
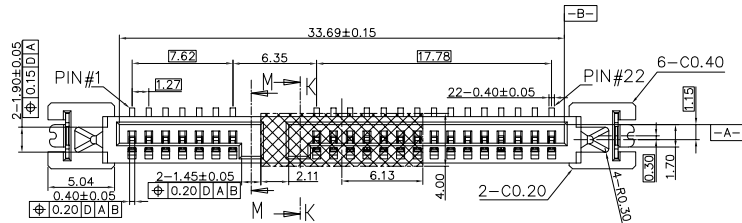

NOTES:

1. MATERIAL:
 - 1.1 HOUSING: HIGH TEMPERATURE THERMOPLASTIC, GLASS FIBER FILLED UL94V-0, COLOR BLACK
 - 1.2 MYLAR: HIGH TEMPERATURE POLYIMIDE, COLOR: BROWN
 - 1.3 TERMINAL: COPPER ALLOY
 - 1.4 PAD: COPPER ALLOY
2. PLATING:
 - 2.1 TERMINAL: UNDERPLATED: NICKEL UNDERPLATING OVER ALL. 5u"Au ON CONTACT AREA, MATTE TIN 100u" ON SOLDER AREA.
 - 2.2 PAD: UNDERPLATED: NICKEL PLATING OVER ALL. MATTE TIN 100u" OVER NICKEL.
3. HALOGEN FREE & RoHS COMPLIANT PRODUCTS.
4. DATE CODE: * * * * *

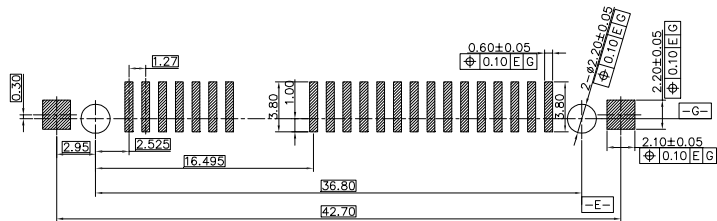
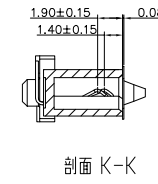
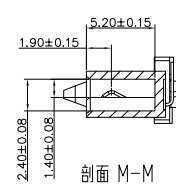
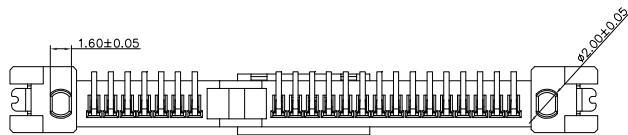
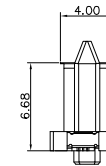
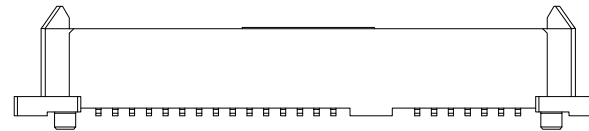
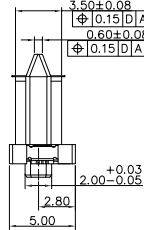
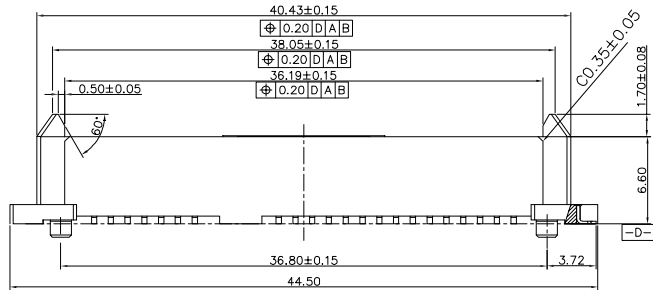

P/N: WL SA F 0-22 2 1 A 0 009

- CONNECTOR: SA-SATA
 MALE FEMALE: F-FEMALE
 ANGLE: 0-180°
 PIN Q'PY: 22PIN
- COLOR: A-BLACK
 PLATING: 1-G/F, 3-5U", 5-15U", 6-30U"
 TERMIPOINT: 2-SMT

RECOMMEND PCB LAYOUT

REV.	REVISION RECORD	DATE	GENERAL TOLERANCES		SCALE: 1:1	NAME	DATE	PART.NO:	DWG.NO:	 WanLian Teconology Co., Ltd
AO	NEW RELEASE	22.05.09	LINEAR	ANGLES	APPROVED	Wang_jr	22.05.09	WLSAF0-2221A0009	ENDE05	
			0.0±0.35	X'REF±6°	DESIGNER	Han_Gao	22.05.09	TITLE:	REV: A0	
			0.00±0.25	X'±3°	DRAWN	LanXuan_Hou	22.05.09	CONN,SATA HDD RECEPTACLE VERTICAL, SMT,H=6.6mm	SHEET: 1/1	
			UNIT:mm	X'±3°						
			SIZE: A4	X'X' ±2°						