

RoHS Compliant

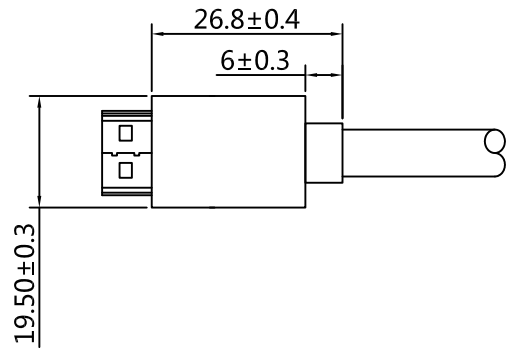

CIRCUIT DIAGRAM		
P1	WIRE COLOR	P2
1	WHITE	1
3	RED	3
2	GND	2
4	WHITE	4
6	BROWN	6
5	GND	5
7	WHITE	7
9	GREEN	9
8	GND	8
10	WHITE	10
12	BLUE	12
11	GND	11
14	WHITE	14
19	YELLOW	19
17	GND	17
13	BROWN	13
15	BLACK	15
16	ORANGE	16
18	WHITE	18
CASE	BRAID SHIELD+D	CASE

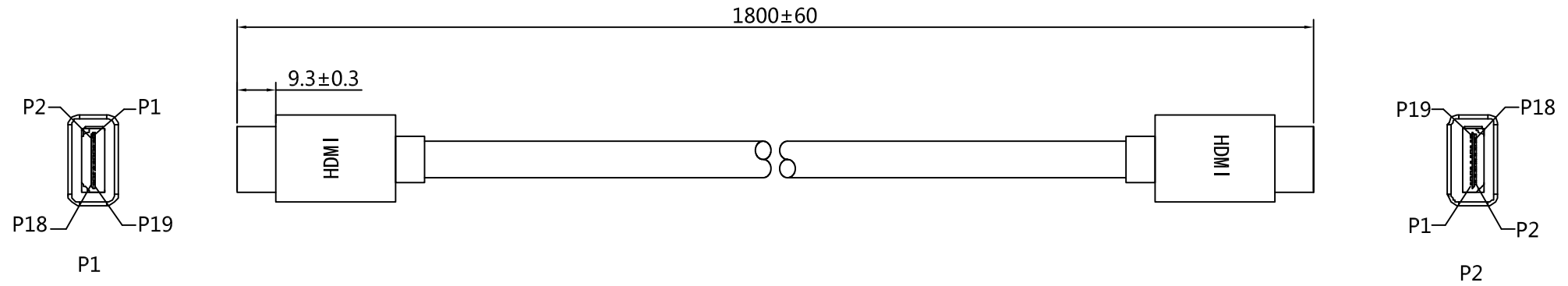
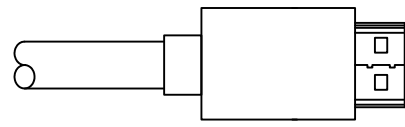

- ELECTRICAL TEST:**
1. OPEN/SHORT/INTERMITTENCE:100%
 2. HI-POT:300V DC/SEC
 3. INSULATION RESISTANCE:10MΩ Min, DC 300V/0.01S
 4. CONDUCTION TEST: 2Ω MAX.
 - 5.Characteristic impedance:100±10 ohm

						一般公差 GENERAL TOLERANCE		绘图 DR.		JCTC ® Shenglan Technology Co LTD <small>TERMINAL & CONNECTORS</small>			料号 PART NO.		
						X.X ±0.5	X' ±10'	wyj					JCT131-F001		
						X.XX ±0.3	X.X' ±5'	校对 CHK.		文件编号 NUMBER					
						X.XXX ±0.2	▲ MAJOR DIM.	wyj		ENDCA08					
△ X	X0	20.06.29	NEW EDITION	wyj	Joshua	单位 UNIT		审核 CHK.		品名 TITLE					
MARK	REV.	DATE	DESCRIPTION	CHK.	APPD.	mm		核准 APPD.		HDMI M to HDMI M L=1800mm					
								Josha		比例 SCALE					
								Josha		1:1					
										SHEET					
										1/1					
										版次 REV.					
										X0					

RoHS Compliant

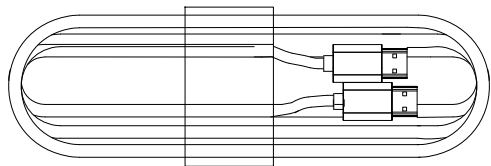

1. Tie the wire with silica gel;

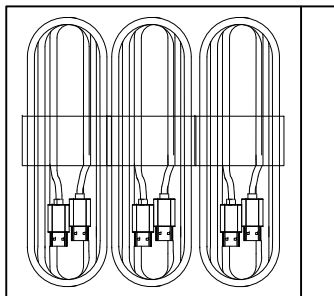

2. Each bag is packed with 3PCS, and the bag mouth is sealed with transparent glue,

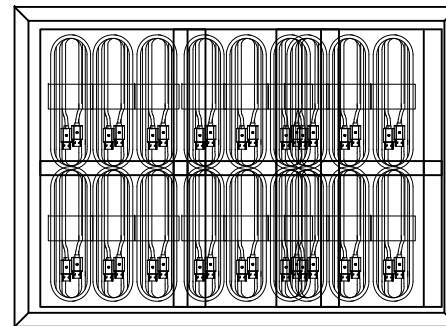

3. bags per layer 12* 3 = 36PCS / layer It should be neatly arranged without messy extrusion;

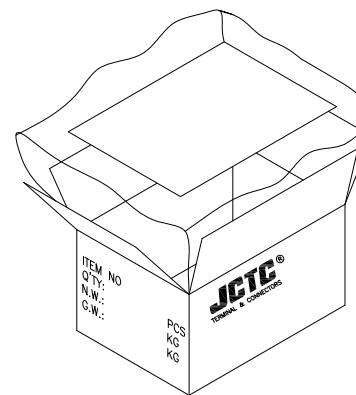

4. As shown in the figure, place the waterproof bag in the outer box and put 1PCS separator on each layer, and 3boxes in a box * 36PCS = 108PCS / box (RER); Carton specifications: 380mm (L) * 320mm (W) * 280mm (H) Material K = K

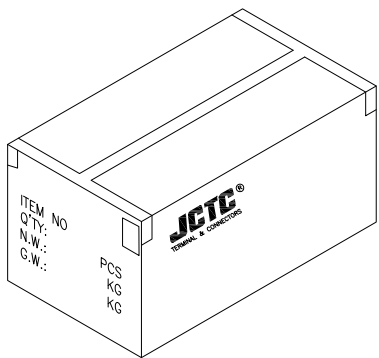

5. Put 2 packs of desiccant in each box, seal the box with transparent tape, seal the box with yellow tape, and fill with foam and other fillers;
6. In-factory labels need to be attached to the sides of the carton;



			一般公差 GENERAL TOLERANCE		绘图 DR.	wyj	 Shenglan Technology Co LTD <small>TERMINAL & CONNECTORS</small>	料号 PART NO.			
			X.X ±0.5	X' ±10'	校对 CHK.	wyj		JCT131-F001			
			X.XX ±0.3	X.X' ±5'	审核 CHK.	Josha		文件编号 NUMBER			
			X.XXX ±0.2	▲ MAJOR DIM.	核准 APPD.	Josha	品名 TITLE				
△ X	X0	20.06.24	NEW EDITION	wyj	Josha	HDMI M to HDMI M L=1800mm			比例 SCALE	SHEET	版次 REV.
MARK	REV.	DATE	DESCRIPTION	CHK.	APPD.				1:1	1/1	X0