

The product using material and processing must conform to the "WI-PZ-001"HSF technical standard control requirements

RoHS

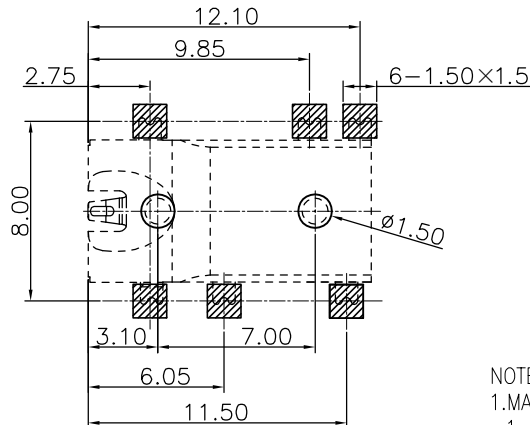

RECOMMEND PCB LAYOUT  
TOLERANCE  $\pm 0.05$

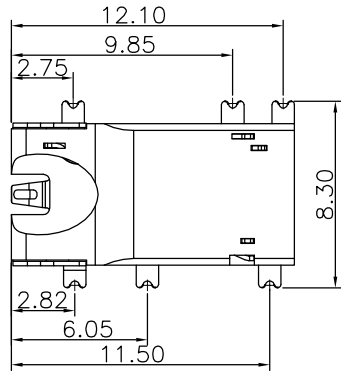
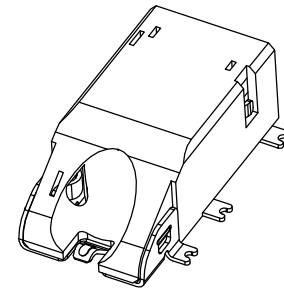

NOTE:

- 1.MATERIAL SPECIFICATION:  
1-1.HOUSING:UL94V-0,  
1-2.CONTACTS:BRASS ALLOY
- 2.PLATING SPECIFICATION:  
2-1.CONTACTS:  
Ni 50u" MIN. UNDER PLATED OVER ALL.  
Au PLATED ON THE FUNCTIONAL AREA OF CONTACT.
- 3.ELECTRICAL PERFORMANCE:  
3-1.CURRENT RATING:0.5A  
3-2.VOLTAGE RATING:30V MAX  
3-3.CONTACT RESISTANCE: 50 milliOHM (Initial) Max.  
3-4.INSULATION RESISTANCE: 100 MEGOHM Min.  
3-5.DIELECTRIC WITHSTANDING VOLTAGE: 500V AC MIN.
- 4.ENVIRONMENTAL PERFORMANCE  
OPERATING TEMPERATURE: -20°C~+85°C.

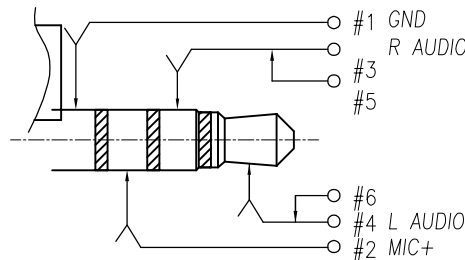
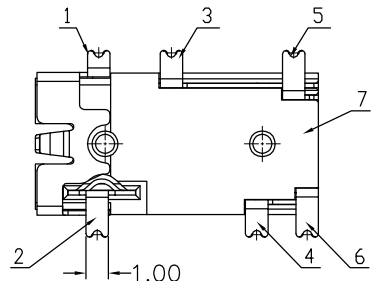
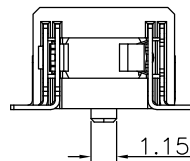
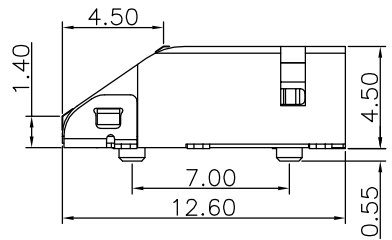
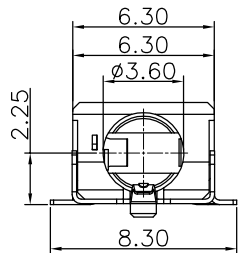

MALE PLUG SCHEMATIC

WLPJF9-06 2 X X 0 015  
PLATING: COLOUR: A:Black  
1-G/F  
2-AU 3U"  
5-AU 15U"  
6-AU 30U"

|      |                 |          |          |                    |          |               |          |          |                                |                   |         |            |
|------|-----------------|----------|----------|--------------------|----------|---------------|----------|----------|--------------------------------|-------------------|---------|------------|
| REV. | REVISION RECORD | DATE     |          | GENERAL TOLERANCES |          | SCALE:<br>1:1 | NAME     | DATE     | PART.NO:<br>WLPJF9-062XX0015   | DWG.NO:<br>ENDE05 |         |            |
| AO   | NEW RELEASE     | 21.01.13 |          | LINEAR             | ANGLES   | APPROVED      | Wang_jr  | 21.01.13 |                                |                   |         |            |
|      |                 |          | 0.0±0.35 | X°REF±6°           | DESIGNER | Ding_bo       | 21.01.13 | TITLE:   |                                |                   |         |            |
|      |                 |          | UNIT:mm  | 0.00±0.25          | X°±3°    | DRAWN         | Ou_jian  | 21.01.13 | 03.5 JACK 4.5H 6PIN short body |                   |         |            |
|      |                 |          | SIZE: A4 | 0.000±0.10         | X°X' ±2° |               |          |          |                                |                   | REV: A0 | SHEET: 1/1 |

WanLian Technology Co., Ltd