

The product using material and processing must conform to the "WI-PZ-001"HSF technical standard control requirements

RoHS

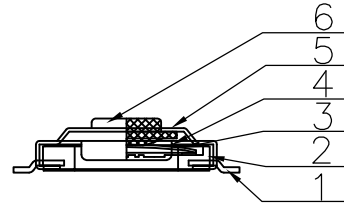
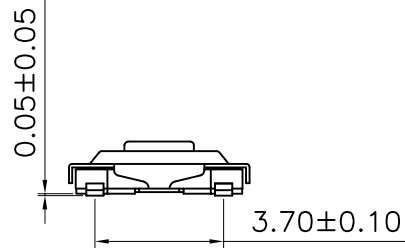
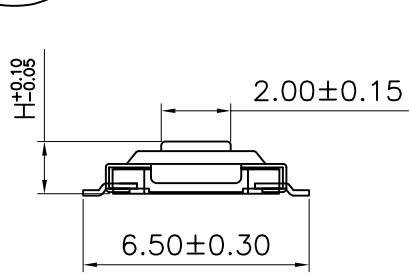

NOTE:

1.MATERIAL SPECIFICATION:

- 1-1.CONTACTS: PHOSPHOR COPPER T=0.15mm
- 1-2.HOUSING:PPA COLOUR:BLACK
- 1-3.SHRAPNEL:STAINLESS STEEL
- 1-4.DUST-PROOF MEMBRANE:POLYIMIDE COLOUR:YELLOW
- 1-5.COVER: SPCC ACID PICKLING
- 1-6.BUTTON: BRASS ACID PICKLING

2.PLATING SPECIFICATION:

- 2-1.CONTACT:AG PLATING ON CONTACT AREA
- 2-2.SHRAPNEL:AG PLATING.

3.ELECTRICAL PERFORMANCE:

- 3-1.RATING CURRENT:50mA DC
- 3-2.RATING VOLTAGE:12V DC
- 3-3.CONTACT RESISTANCE: 100mΩ MAX;
- 3-4.INSULATION RESISTANCE:100MΩ MIN
- 3-5.WITHSTANDING VOLTAGE: AC 250V/50HZ,1MIN

4.MECHANICAL PERFORMANCE:

- 4-1.DURABILITY: 100000 CYCLES.

5.OPERATION TEMPERATURE RANGE:-20°C~+85°C

6.PACKAGE SPEC: REEL

7.P/N: WLSW10-04 2 8 A X 047

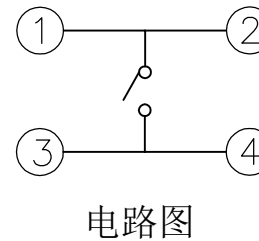
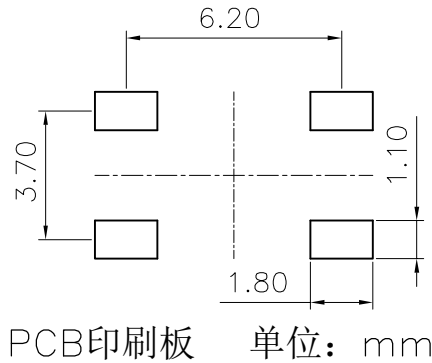
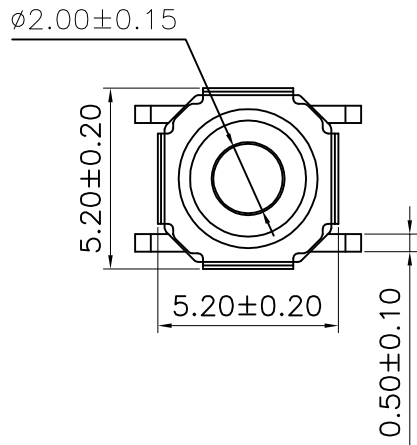

- PLATED: 8.AG
- COLOUR: A.BLACK
- A.H=1.50mm
 - B.H=2.00mm
 - C.H=2.50mm
 - D.H=3.10mm
 - E.H=4.00mm
 - F.H=4.30mm
 - G.H=5.00mm
 - H.H=6.00mm
 - I.H=7.00mm
 -

N (按力值gf)				
100	160	250	350

REV.	REVISION RECORD	DATE	UNIT:mm	GENERAL TOLERANCES		SCALE: 1:1	NAME	DATE	PART.NO:	DWG.NO:	WanLian Teconology Co., Ltd
A0	NEW RELEASE	21.01.13		LINEAR	ANGLES	APPROVED	Wang_jr	21.01.13	WLSW10-0428AX047	ENDE05	
			0.00±0.25	X°±3°	DESIGNER	Han_Gao	21.01.13	TITLE:	TACT SWITCH	REV: A0	SHEET: 1/2
			0.000±0.10	X°X' ±2°	DRAWN	Zijun_Huang	21.01.13				

The product using material and processing must conform to the "WI-PZ-001"HSF technical standard control requirements

RoHS

PULL OUT DIRCTION
出料方向

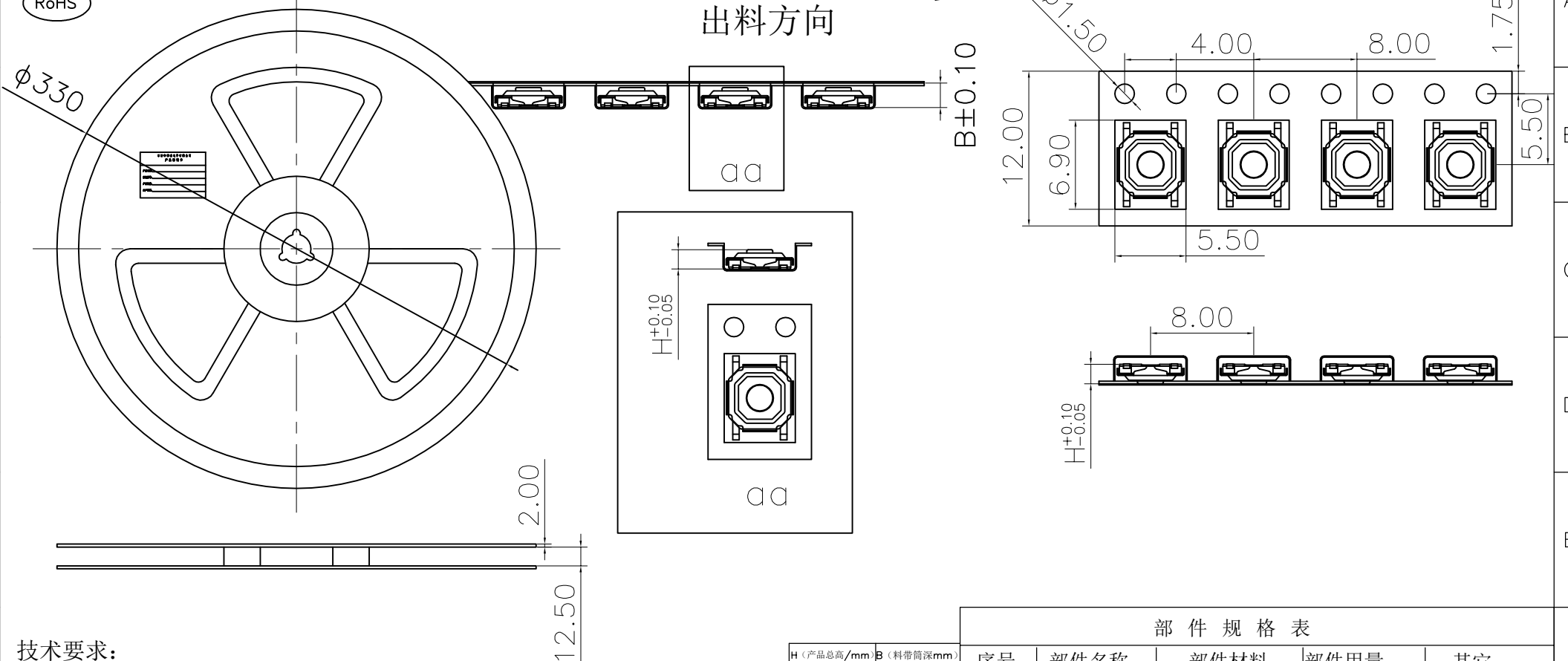

技术要求:

1. 本产品不含环境危险物质，适用于RoHS指令2011/65/EU要求。
2. 吸塑盒：用长6.9mm，宽5.5mm，编带定位孔间距为 4 ± 0.05 mm。
3. 编带封塑时，一定要注意其封塑牢固度，无因封带开裂而导致产品脱落等不良现象。
4. 卷盘起始段要预留5到10PCS以上的空槽位置，防止卷盘内圆卷圈过小导致产品焊脚损坏；卷盘末端预留一外圈的空槽，防止卷盘碰撞对产品的损失；一卷盘按产品高度规格对应的要求数量进行编带。

部件规格表

序号	部件名称	部件材料	部件用量	其它
1	卡件	0.15磷铜	1PCS	镀银白色
2	基座	PPA	1PCS	黑色
3	弹片	不锈钢	1PCS	镀银白色
4	防尘膜	聚酰亚胺(杜邦)	1PCS	黄色
5	盖板	SPCC	1PCS	酸洗
6	按钮	黄铜	1PCS	酸洗

REV.	REVISION RECORD	DATE	GENERAL TOLERANCES	SCALE:	NAME	DATE	PART.NO:	DWG.NO:
A0	NEW RELEASE	21.01.13	LINEAR 0.0 ± 0.35	1:1	Wang_jr	21.01.13	WSLW10-0428AX047	ENDE05
			ANGLES $X' \pm 3'$	APPROVED	Han_Gao	21.01.13	TITLE:	 WanLian Teconology Co., Ltd REV: A0 SHEET: 2/2
			0.00 ± 0.25	DESIGNER	Zijun_Huang	21.01.13	TACT SWITCH PACKAGE DRAWING	
			UNIT:mm SIZE: A4 0.000 ± 0.10	DRAWN				