

The product using material and processing must conform to the "WI-PZ-001" HSF technical standard control requirements

RoHS+HF

NOTE:

- MATERIAL SPECIFICATION:
 - HOUSING: LCP, UL94V-0
 - CONTACTS: BRASS
- PLATING SPECIFICATION:
 - CONTACTS: TIN/GOLD FLASH PLATED OVER ALL.
- ELECTRICAL PERFORMANCE:
 - CURRENT RATING: 5A
 - CONTACT RESISTANCE: 10mΩ MAX
 - INSULATION RESISTANCE: 1000MΩ Min
 - WITHSTANDING VOLTAGE: 1000V AC
- ENVIRONMENTAL PERFORMANCE:
 - OPERATING TEMPERATURE: -40°C~+105°C.
- PACKAGE SPEC: REEL
- MATES WITH C3030 SERIES HOUSING
- P/N:

$\triangle A1$ C3030 W 9-2 XX 2 X X 0
 SERIES NO: _____ COLOR: A-BLACK S-NATURE
 CONNECTOR: W-WAFER PLATING: A-ALL AU G/F C-BRIGHT TIN D-MATTE Tin
 ANGLE: 9-90°
 ROW NO: 2-DOUBLE ROW
 PIN Q'PY: 02~16 TERMIPOINT: 2-SMT

Circuit	Dimensions(mm)		Circuit	Dimensions(mm)	
	A	B		A	B
2*01	6.65	---	2*07	24.65	18.00
2*02	9.65	---	2*08	27.65	21.00
2*03	12.65	6.00	2*09	30.65	24.00
2*04	15.65	9.00	2*10	33.65	27.00
2*05	18.65	12.00	2*11	36.65	30.00
2*06	21.65	15.00	2*12	39.65	33.00

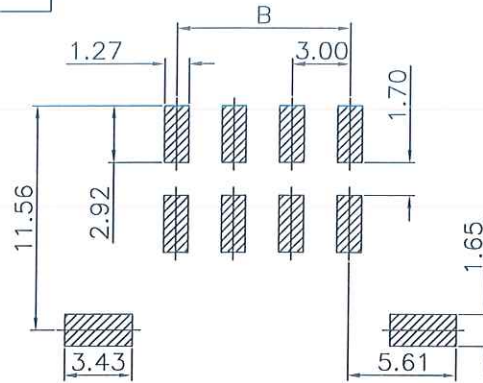
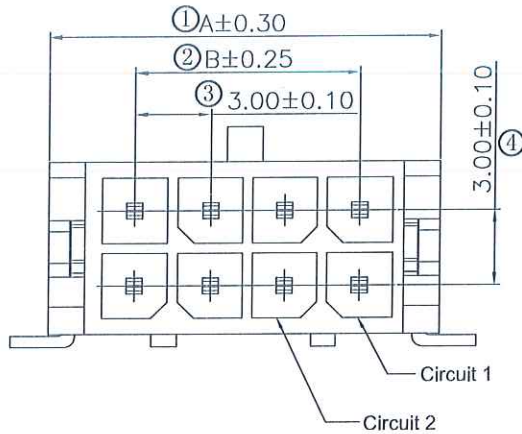

RECOMMENDED PCB LAYOUT
(GENERAL TOLERANCE: ±0.05)

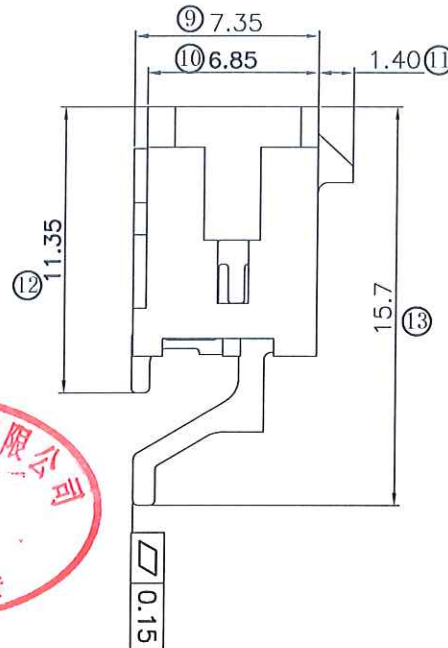
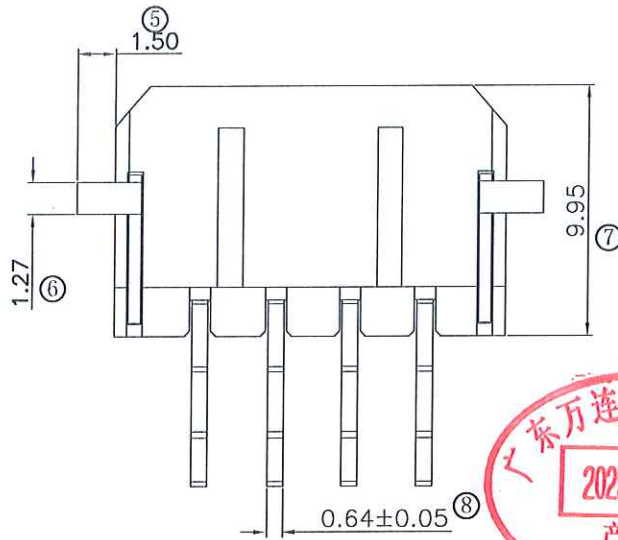



REV.	REVISION RECORD	DATE	UNIT: mm	GENERAL TOLERANCES	SCALE: 1:1	NAME	DATE	PART.NO:	DWG.NO:	 WanLian Technology Co., Ltd REV: A2 SHEET: 1/3
A0	NEW RELEASE	21.01.13	mm	LINEAR	1:1			C3030W9-2XX2XX0	ENDE05	
A1	PART NUMBER RENEWAL	23.09.14	mm	0.0±0.35	APPROVED	张明	25.12.12			
A2	ADD THE EXPLANATION ON PAGE 2	25.12.12	mm	0.00±0.25	CHECK	李强	25.12.12	TITLE: 3.0MM PITCH 90° SMT DUAL ROW WAFER		
			SIZE: A4	0.000±0.10	DRAWN	黄登	25.12.12			

The product using material and processing must conform to the "WI-PZ-001"HSF technical standard control requirements

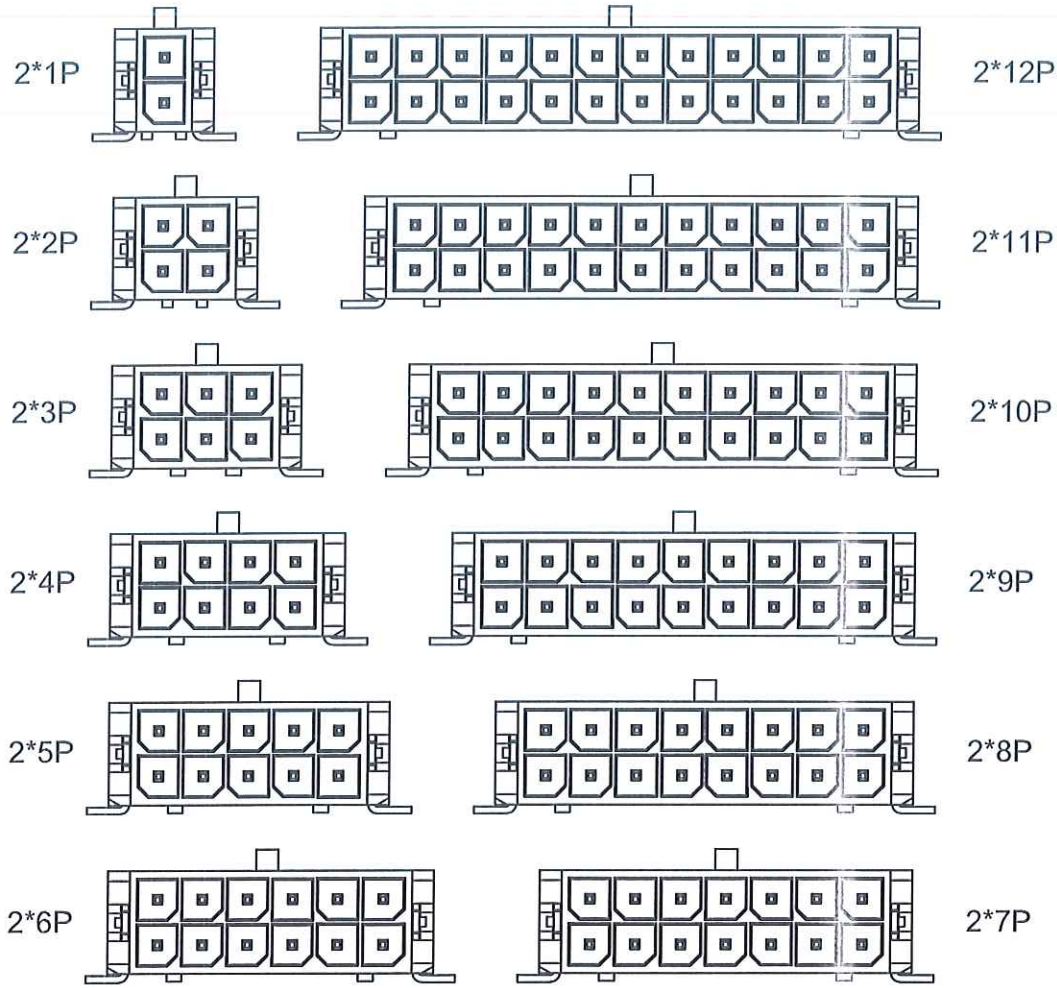
RoHS+HF



REV.	REVISION RECORD	DATE		GENERAL TOLERANCES		SCALE: 1:1	NAME	DATE	PART.NO:	DWG.NO:	 WanLian Technology Co., Ltd
A0	NEW RELEASE	21.01.13		LINEAR	ANGLES	APPROVED	<i>3/8/14</i>	<i>25.12.12</i>	C3030W9-2XX2XX0	ENDE05	
A1	PART NUMBER RENEWAL	23.09.14	0.0±0.35	X'REF±6°	CHECK	<i>丁洪</i>	<i>25.12.12</i>	TITLE: 3.0MM PITCH 90° SMT DUAL ROW WAFER	REV: A2	SHEET: 2/3	
A2	ADD THE EXPLANATION ON PAGE 2	25.12.12	UNIT:mm SIZE: A4	X'±3° X'X' ±2°	DRAWN	<i>黄岩</i>	<i>25.12.12</i>				

The product using material and processing must conform to the "WI-PZ-001" HSF technical standard control requirements

RoHS+HF

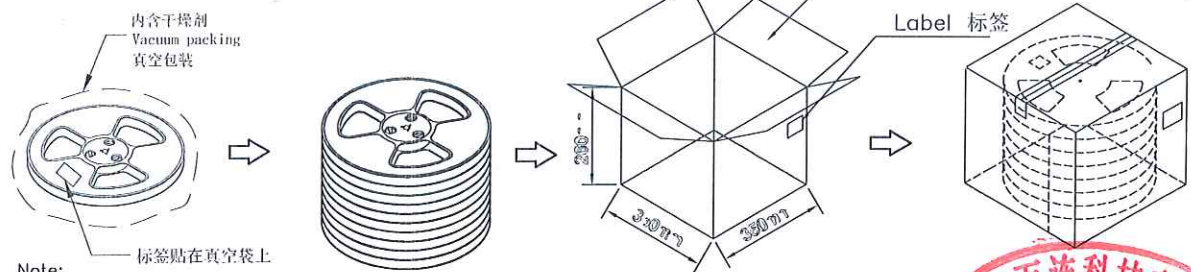
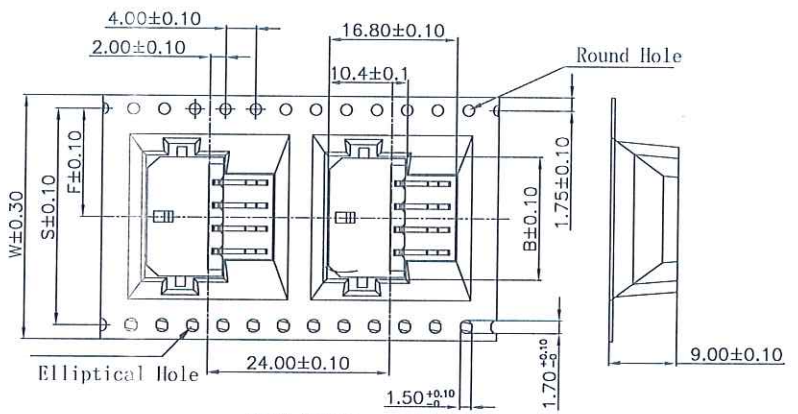
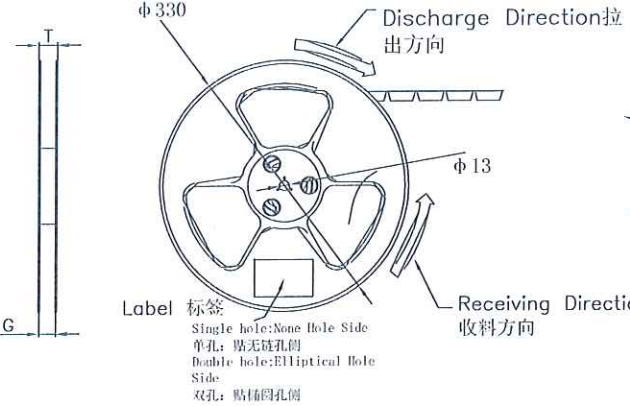
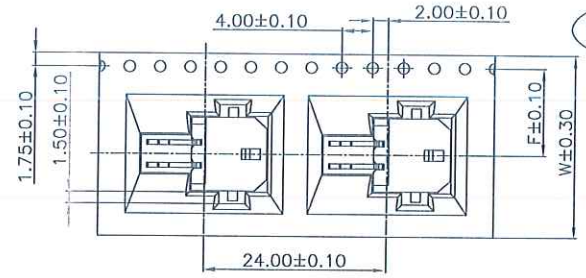
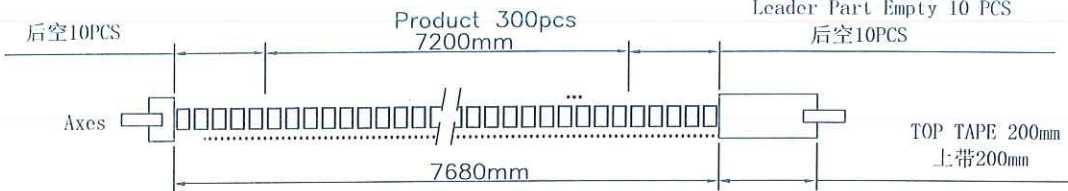

Circuit	W	S	F	T	G	Cover Top(±0.1)	Carrier Top(±0.1)	BO	REEL /PCS	CARTON /R	CARTON /PCS
2*01								7.1	300	8	2400
2*02	24	/	11.50	27.0	25.4	21.3		10.1			
2*03	32	28.4	14.20	35.0	33.4	25.5		13.1	300	6	1800
2*04								16.1			
2*05								19.1			
2*06	44	40.4	20.20	48.5	44.4	37.5		22.1	300	5	1500
2*07								25.1			
2*08								28.1			
2*09								34.1			
2*10								37.1	300	4	1200
2*11	56	52.4	26.20	60.5	56.4	49.5		40.1			
2*12											

Note:
 1.Carrier Amber is WITHIN 1mm In 100mm;带长100mm内容许弯曲度1mm
 2.10SPROCKET HOLE PITCH CUMULATIVE TOLERANCE±0.2MM; 圆孔十个孔距距离累计允许公差为±0.2mm
 3.CARRIER TAPE MATERIAL FOR PS;下带材质为PS材质; COLOR颜色: 雾透
 4.BRACER保护袋: COLOR颜色: MATURAL; 厚度0.40mm最小
 5.THINKNESS=0.50±0.05; 材料厚度为0.50±0.05mm
 6.COVER TAPE上带: 冷风白黏带

广东万连科技有限公司
 2025.12.12
 产品中心
 基本文件管理

REV.	REVISION RECORD	DATE	GENERAL TOLERANCES	SCALE: 1:1	NAME	DATE	PART.NO:	DWG.NO:
A0	NEW RELEASE	21.01.13	LINEAR	1:1			C3030W9-2XX2XX0	ENDE05
A1	PART NUMBER RENEWAL	23.09.14	0.0±0.35	APPROVED	李博	25.12.12		
A2	ADD THE EXPLANATION ON PAGE 2	25.12.12	0.00±0.25	CHECK	李博	25.12.12		
			0.000±0.10	DRAWN	黄宇娟	25.12.12	TITLE: 3.0MM PITCH 90° SMT DUAL ROW WAFER	REV: A2 SHEET: 3/3

